



McIntosh Laboratory, Inc. 2 Chambers Street Binghamton, New York 13903-2699 Phone: 607-723-3512 www.mcintoshlabs.com

MAC7200
Receiver
Owner's Manual





Important Safety Information is supplied in a separate document “Important Additional Operation Information Guide”

Thank You

Your decision to own this McIntosh MAC7200 Receiver ranks you at the very top among discriminating music listeners. You now have “The Best.” The McIntosh dedication to “Quality,” is assurance that you will receive many years of musical enjoyment from this unit.

Please take a short time to read the information in this manual. We want you to be as familiar as possible with all the features and functions of your new McIntosh.

Please Take A Moment

The serial number, purchase date and McIntosh Dealer name are important to you for possible insurance claim or future service. The spaces below have been provided for you to record that information:

Serial Number:

Purchase Date:

Dealer Name:

Technical Assistance

If at any time you have questions about your McIntosh product, contact your McIntosh Dealer who is familiar with your McIntosh equipment and any other brands that may be part of your system. If you or your Dealer wish additional help concerning a suspected problem, you can receive technical assistance for all McIntosh products at:

McIntosh Laboratory, Inc.
2 Chambers Street
Binghamton, New York 13903
Phone: 607-723-3512
Fax: 607-724-0549

Customer Service

If it is determined that your McIntosh product is in need of repair, you can return it to your Dealer. You can also return it to the McIntosh Laboratory Service Department. For assistance on factory repair return procedure, contact the McIntosh Service Department at:

McIntosh Laboratory, Inc.
2 Chambers Street
Binghamton, New York 13903
Phone: 607-723-3515
Fax: 607-723-1917

Table of Contents

Safety Instructions.....	2
(Separate Sheet).....	Important Additional
	Operation Information Guide
Thank You and Please Take a Moment	2
Technical Assistance and Customer Service.....	2
Table of Contents	2
General Information	3
Connector and Cable Information	4
Introduction	5
Performance Features	5-6
Dimensions	7
Installation	8
Connections:	
Rear Panel Connections.....	9
(Separate Sheet)	Mc1A
Connecting Components	10
Connection Diagrams (Separate Sheet).....	Mc2A/2B
Passthru Connections	11
Connecting for Bi-Amplification	12
Connecting Loudspeakers	13-14
Remote Control and Front Panel:	
Remote Control Push-buttons	16
How to use the Remote Control.....	17

Front Panel Displays, Controls, Push-buttons and Jack	18
--	----

Setup Mode:

How to Operate the Setup Mode	19
-------------------------------------	----

Setup Functions:

Default Settings	19
Firmware Version	19
Source Input Renaming	20 21
Output Settings	21
Power Control Triggers 1 and 2	22
Data Ports.....	23
Passthru.....	23
USB Automute	23
Comm Port Baud Rate	24
Remote Control Codes.....	24
IR Sensor.....	24
Power Mode	25
Tuner Presets.....	25
Tuner Regions	25
Factory Reset	27

Microprocessor Reset	27
----------------------------	----

Operation:

How to Operate the MAC7200.....	28-36
---------------------------------	-------

Trim Functions:

Balance.....	28
Trim Level.....	29
Tone Control.....	29
Bass	29
Treble.....	30
Phono Adjustments	30
Mono/Stereo Mode	30
Meter Backlight	31
Display Brightness.....	31
Headphone HXD.....	31

Tone, Trim, Mute	31
Headphone Jack, Power Output Meters, Power Guard, Separate Power Amplifier, Using Output 2	32
Passthru, Optical and Coaxial Digital Inputs	33
Operating the FM and AM Tuner	33-34
AM or FM Band Selection.....	33
Default Station Tuning.....	33
Seek Tuning Type	33

Table of Contents, con't

Operating the FM and AM Tuner, con't	
Direct Access Tuning.....	34
Preset Tuning	34
Create a Preset	34
Erase a Preset.....	34
Selecting a Preset.....	34
Tuner Text	34
USB Input Operation with a Computer	35-36
Specifications.....	37-38
Packing Instructions	39

General Information

1. For additional connection information, refer to the owner's manual(s) for any component(s) connected to the MAC7200.
2. Apply AC Power to the MAC7200 and other McIntosh Component(s) only after all the system components are connected together. Failure to do so may cause a malfunction of system operations as the Microprocessor's Circuitry inside the components is active when AC Power is applied.
3. **The MAC7200 includes an Auto Off Power Save Feature and the default setting is enabled.** For additional information including how to disable it, refer to page 22.
4. When Power Amplifier Protection Circuitry of the MAC7200 has activated, the Front Panel Power Guard LEDs are illuminated continuously and the sound will be muted.
5. When the Power Transformer has overheated due to improper ventilation and/or high ambient operating temperature, AC Power is removed from the MAC7200. Normal operation will resume when the operating temperature is in a safe range again.
6. For the best performance and safety, it is important to always match the impedance of the Loudspeaker to the Power Amplifier connections. Refer to pages 13 and 14.
Note: The impedance of a Loudspeaker actually varies as the Loudspeaker reproduces different frequencies. As a result, the nominal impedance rating of the Loudspeaker (usually measured at a midrange frequency) might not always agree with the impedance of the Loudspeaker at low frequencies where the greatest amount of power is required. Contact the Loudspeaker Manufacturer for additional information about the actual impedance of the Loudspeaker before connecting it to the McIntosh MAC7200.
7. The MAC7200 Remote Control is capable of operating other components. For additional information go to www.mcintoshlabs.com.
8. RF Multipath interference can occur when the MAC7200 receives two or more signals from the Tuned in FM Broadcast Station. The first signal received is the direct signal from the station and additional signals received are delayed because they have reflected off of a building or terrain (hill/mountain). This delay results in an increase in distortion and a reduction in Stereo Separation. To reduce or eliminate Multipath, reorient the direction of the FM Antenna for minimum indication of Multipath even if the Signal Strength indicates less signal. Refer to pages 33 and 34.
9. The IR Input, with a 1/8 inch mini phone jack, is configured for non-McIntosh IR sensors such as Xantech Model DL85K Kit. Use a Connection Block such as a Xantech Model ZC21 when two or more IR sensors need to be connected to the MAC7200. The signal from a connected External IR Sensor will have priority over the signal from the Front Panel IR Sensor.
10. When discarding the unit, comply with local rules or regulations. Batteries should never be thrown away or incinerated but disposed of in accordance with the local regulations concerning battery disposal. 
11. For additional information on the MAC7200 and other McIntosh Products please visit the McIntosh Web Site at www.mcintoshlabs.com.

Connector and Cable Information

XLR Connectors

Below is the Pin configuration for the XLR Balanced Input Connectors on the MAC7200. Refer to the diagram for connection:

- PIN 1: Shield/Ground
- PIN 2: + Output
- PIN 3: - Output

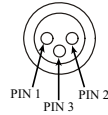

Power Control and Trigger Connectors

The Power Control Trigger Output Jacks send and Passthru Input Jack receives Power On/Off Signals (+12 volt/0 volt) when connected to other McIntosh Components. An additional connection is for controlling the illumination of the Power Output Meters on McIntosh Power Amplifiers. A 3.5mm stereo mini phone plug is used for connection to the Power Control, Trigger and Passthru Outputs.

Main, Trig 1&2 and Pass Thru

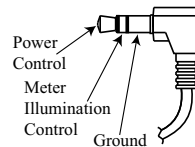

Data Port Connectors

The Data Out Ports send Remote Control Signals to Source Components. A 3.5mm stereo mini phone plug is used for connection.

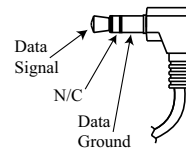

IR IN Port Connectors

The IR IN Port also uses a 3.5mm stereo mini phone plug and allows the connection of other brand IR Receivers to the MAC7200.

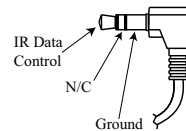

RS232-C Data Port Cable

The RS232 Data Cable is a 3.5mm stereo mini phone plug to a subminiature DB 9 connector:

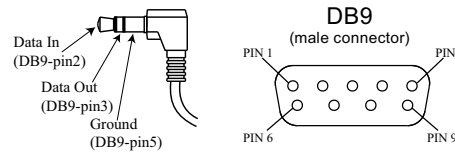

Output Terminal Connector

When cables with spade lugs are used for Loudspeaker Connection, the spade lugs need an opening of at least 3/10 inch (7.6mm).

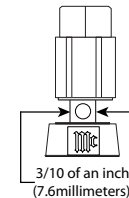

McIntosh Plug-In Jumper Connector

The MAC7200 utilizes two phono style Plug-In Jumpers to connect the Preamplifier Output to the Power Amplifier Input.

Note: The Jumper Connector is available from the McIntosh Parts Department:

McIntosh Jumper Connector Part No. 117781

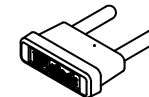

FM Dipole Antenna

The MAC7200 FM Tuner Circuitry requires the connection of an external Antenna for FM reception. A "FM Dipole Antenna" is available from the McIntosh Parts Department:

FM Dipole Antenna Part No. 173033

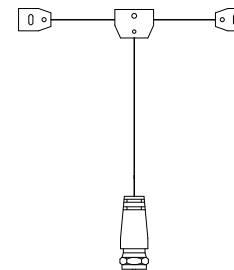

McIntosh RAA2 AM Antenna

The AM Tuner Circuitry requires the connection of the external McIntosh RAA2 Antenna for AM reception. The RAA2 Antenna is supplied with the MAC7200 Receiver. The "AM Antenna" is also available from the McIntosh Parts Department:

RAA2 AM Antenna with connecting cable Part No. 31036400

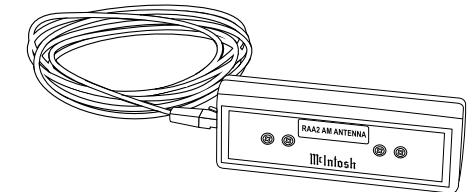

Introduction

Now you can take advantage of traditional McIntosh standards of excellence in the MAC7200 Receiver.

The flexible Preamplifier section provides connections for various input sources and may also be used to drive an external Power Amplifier(s).

The AM/FM Tuner section provides superb reception from Radio Stations. It uses the latest in technology for the best sound quality, along with the convenient operation.

The Power Amplifier section of the MAC7200, with a power output of 200 watts per channel, will drive a pair of quality Loudspeakers to a high level of performance.

The MAC7200 reproduction is sonically transparent and absolutely accurate. The McIntosh Sound is “The Sound of the Music Itself.”

Performance Features

• Power Output with Patented Autoformer

The MAC7200 consists of a 200 watts per channel Power Amplifier with less than 0.005% distortion. The McIntosh designed and manufactured Autoformer allows connection of 2, 4 or 8 ohm Loudspeakers. The Power Amplifier uses ThermalTrak¹ Output Transistors for lower distortion and cool operation.

• Power Guard

The patented McIntosh Power Guard circuit prevents amplifier clipping and protects your valuable Loudspeakers.

• Sentry Monitor and Thermal Protection

McIntosh Sentry Monitor power output stage protection circuits ensure the MAC7200 will have a long and

¹ ThermalTrak™ and ON Semiconductor are trademarks of Semiconductor Components Industries, LLC

trouble free operating life. Built-in Thermal Protection Circuits guard against overheating.

• Power Meters

The Illuminated Power Output Meters are peak responding, and indicate the power output of the amplifier.

• McIntosh Custom Binding Posts

McIntosh Patented gold plated Power Amplifier Output Terminals deliver high current output. They accept large diameter wire and spade lugs. Banana plugs may also be used only in the United States and Canada.

• Electronic Switching and Balanced Connections

The Preamplifier uses Logic Circuits Controlled Electromagnetic Switches on all inputs and operating functions for reliable, noiseless, distortion free switching. There is a Balanced Input for connection of a source component.

• Digital Audio Inputs

The Digital Inputs decode PCM and DSD Signals from external sources. Coaxial and Optical Inputs process Digital Signals up to 192kHz with 24-Bit resolution. The Digital MCT Input Circuitry directly decodes SACD/CD signals from an external Transport component. The USB Input for streaming audio processes Digital Signals up to 384kHz with 32-Bit resolution, decodes up to DSD256 Digital Signals and DXD 24-Bit with a sampling rate up to 384kHz.

• Moving Coil and Moving Magnet Phono Inputs

The MAC7200 has two precision Phono Preamplifier Circuits for Moving Coil and Moving Magnet Phono Cartridges. Both circuits use the latest designs to provide the lowest possible noise, distortion and flat

frequency response. The MC Phono Cartridge Input has selectable loading.

• Tone Controls

The Bass and Treble Trim Controls provide up to 12dB of boost or cut. The MAC7200 remembers the Bass and Treble Setting for each input.

• Multifunction Display

The Front Panel Display indicates source selection, volume levels and setup functions. For Tuner operation it also indicates Station Frequency, Signal Strength, Stored Station Presets and Tuner Setup Functions.

• Special FM RF Circuitry

The Tuner Module RF Circuitry receives strong local FM Station Signals without distortion and receives even the weakest of FM Signals with low noise.

• High Dynamic Range IF FM Circuitry

The all important IF circuitry in the Tuner Module provides dynamic bandwidth control optimizing performance at all times with varying reception conditions.

• Information Service

The Front Panel Display can display various text information from the Broadcast Station². This text information may include the Station Call Sign, Music Genre, Artist Name and Song Title.

² The display of text information is dependent on the Broadcast Station transmitted signal, the text information language and the Broadcast Station country of origin. The Tuner Module supports English Language Alphabet Characters.



Performance Features, con't

• Preset Stations and Permanent Memory

Twenty AM and Twenty FM station presets make it easy to listen to your favorite stations. Station Presets and Function Modes are retained in Permanent Memory even when AC power is switched Off.

• RAA2 External AM Antenna

The RAA2 External AM Antenna provides the perfect match to the Tuner Module AM Circuitry. The 20 foot (6 meter) connection cable allows placement of the AM Antenna away from electronic equipment which can produce RF Interference to weak AM signals.

• Power Control Output and Trigger Assignment

A Power Control connection for convenient Turn-On of McIntosh Power Amplifiers, Source Components and Accessories is included. The Power Control Trigger Outputs may be assigned to activate when a given Input/Output is selected.

• PassThru Mode

The Automatic PassThru Mode allows the MAC7200 to become part of a Multichannel Sound System for DVD-Audio, SACD and Home Theater Movies.

• Remote Control

The Data Ports together with the supplied Remote Control provide control of McIntosh Source Components connected to the MAC7200.

• Special Power Supply

The large Power Transformer, multiple filter capacitors with 120 Joules of Energy Storage and regulated Power Supply, ensures stable noise free operation even though the power line varies.

• Glass Front Panel

The famous McIntosh Illuminated Glass Front Panel using long life Light Emitting Diodes (LEDs) ensures the pristine beauty of the MAC7200 will be retained for many years.

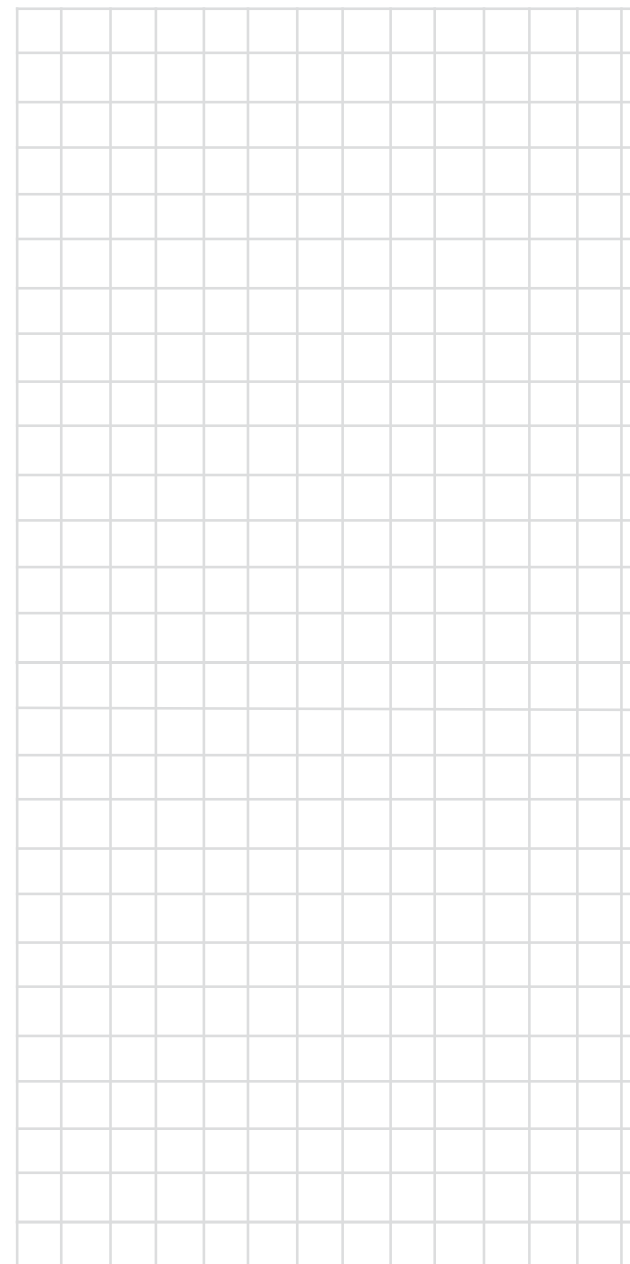

Dimensions

The following dimensions can assist in determining the best location for your MAC7200. There is additional information on the next page pertaining to installing the MAC7200 into cabinets.

Front View of the MAC7200

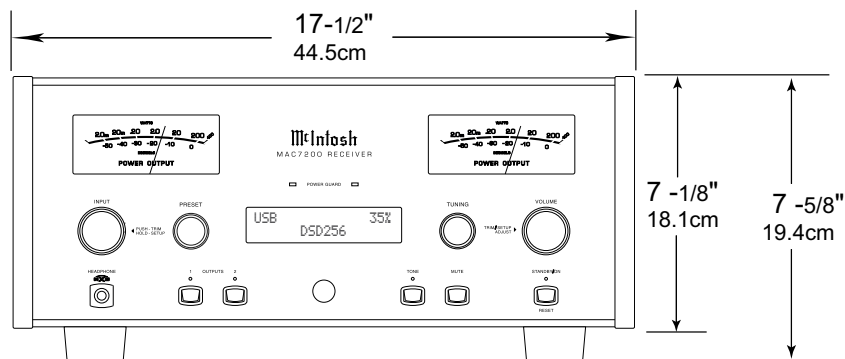

Rear View of the MAC7200

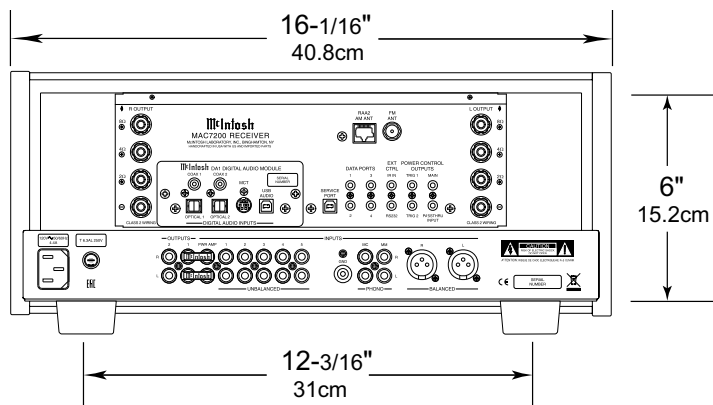

Side View of the MAC7200

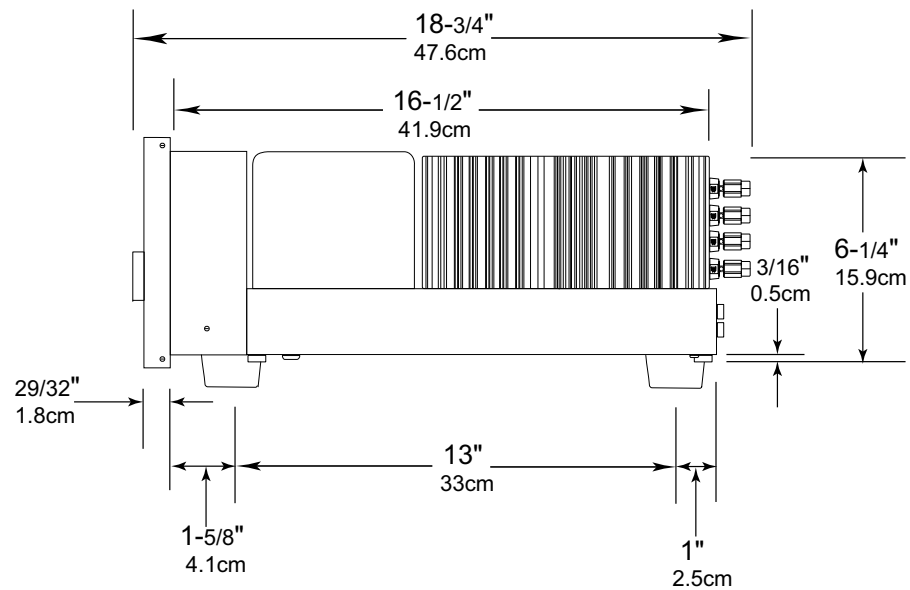

Installation

The MAC7200 can be placed upright on a table or shelf, standing on its four feet. It also can be custom installed in a piece of furniture or cabinet of your choice. The four feet may be removed from the bottom of the MAC7200 when it is custom installed as outlined below. The four feet together with the mounting screws should be retained for possible future use if the MAC7200 is removed from the custom installation and used free standing. The required panel cutout, ventilation cutout and unit dimensions are shown.

Always provide adequate ventilation for your MAC7200. Cool operation ensures the longest possible operating life for any electronic instrument. Do not install the MAC7200 directly above a heat generating component such as a high powered amplifier. If all the components are installed in a single cabinet, a quiet running ventilation fan can be a definite asset in maintaining all the system components at the coolest possible operating temperature.

A custom cabinet installation should provide the following minimum spacing dimensions for cool operation.

Allow at least 6 inches (15.24cm) above the top, 2 inches (5.08cm) below the bottom and 2 inches (5.1cm) on each side of the Integrated Amplifier, so that air-flow is not obstructed. Allow 20 inches (50.8cm) depth behind the front panel. Allow 1-7/6 inch (3.66cm) in front of the mounting panel for knob clearance. Be sure to cut out a ventilation hole in the mounting shelf according to the dimensions in the drawing.

**MAC7200 Front Panel
Custom Cabinet Cutout**

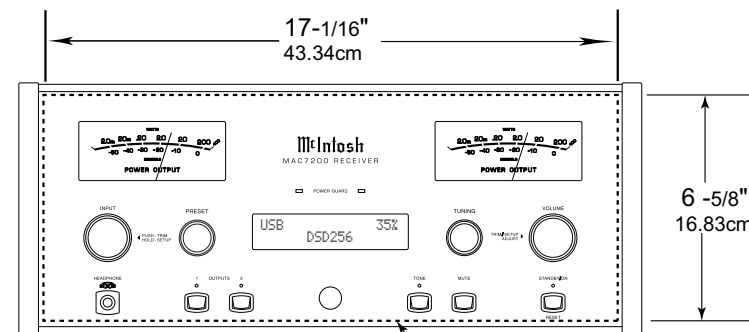

**MAC7200 Side View
in Custom Cabinet**

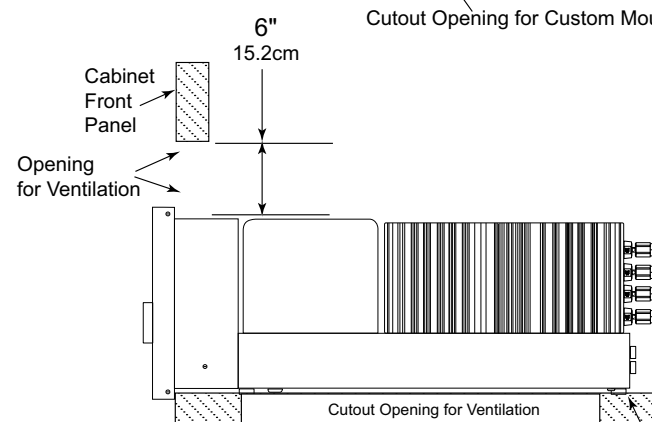

**MAC7200 Bottom View
in Custom Cabinet**

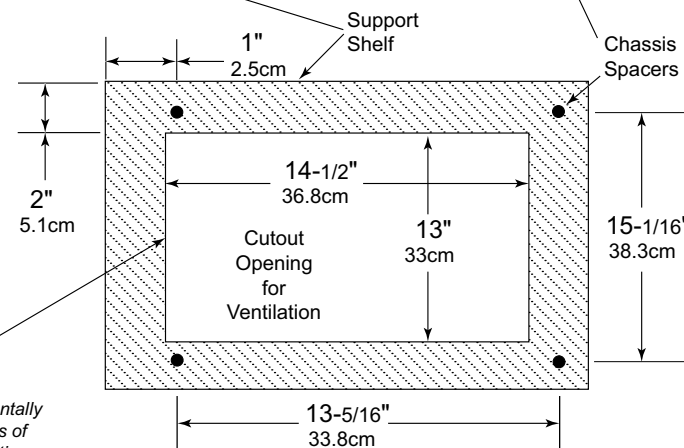

Note: Center the cutout horizontally on the unit. For purposes of clarity, the above illustration is not drawn to scale.

Rear Panel Connections

The identification of Rear Panel Connections for the MAC7200 Receiver is located on a separate folded sheet contained in the Owner's Manual Packet. Refer to separate sheet "MclA" for the Rear Panel Connections.

MAC7200 Receiver

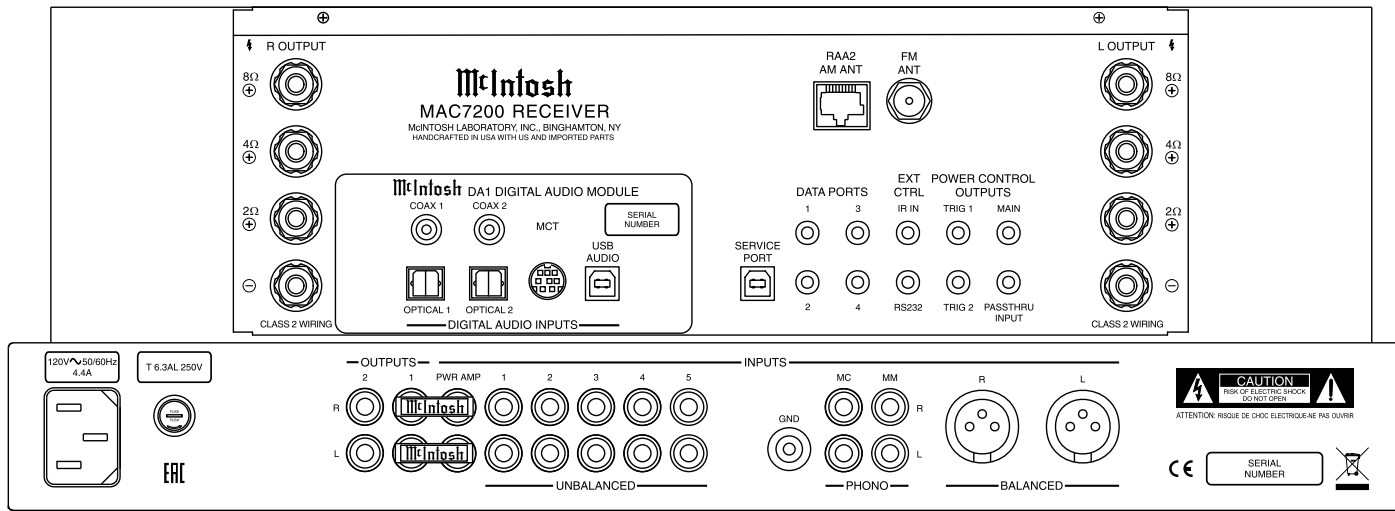

Connecting Components

The MAC7200 has the ability to automatically switch power On/Off to McIntosh Source Components via the Power Control (Trigger) connections. The Data Port Connections allow for the remote operation of basic functions using the MAC7200 Remote Control. With an external sensor connected to the MAC7200, remote control operation of the system is possible from another room and/or when the MAC7200 is located in a cabinet with the doors closed.

The connection instructions below, together with the MAC7200 Input and Output Connection Diagrams located on the separate folded sheet “Mc2A/2B”, are an example of a typical audio system. Your system may vary from this, however the actual components would be connected in a similar manner. For additional information refer to “Connector and Cable Information” on page 4.

Power Control Connections:

1. Connect a Control Cable from the MAC7200 POWER CONTROL MAIN Jack to the Power Control In on the Turntable.
2. Connect a Control Cable from the McIntosh Turntable Power Control Out Jack to the Digital Audio Player Trigger In Jack.
3. Connect a Control Cable from the Digital Audio Player Trigger Out Jack to the SACD/CD Transport Power Control In Jack.
4. Connect a Control Cable from the SACD/CD Transport Power Control Out Jack to the Media Server PWR CTRL (Power Control) In Jack.
5. Optionally connect a Control Cable from the MAC7200 POWER CONTROL TRIG (Trigger) 2 Jack to the Power Amplifier (Secondary Room) Power Control In Jack.
6. Connect any additional McIntosh Components in a similar manner, as outlined in steps 1 thru 5.

Data Control Connections:

7. Connect a Control Cable from the MAC7200 DATA PORT Jack 2 to the SACD/CD Player Data In Jack.
8. Connect a Control Cable from the MAC7200 Jack 1 to the Media Server Data In Jack.
9. Connect any additional McIntosh Components in a similar manner, as outlined in steps 7 thru 8.

Sensor Connection:

10. Optionally, connect the cable with stereo mini plug coming from the compatible External Sensor to the EXT CTRL (External Control) IR IN Jack on the MAC7200. Refer to page 3 “General Information, note 8” for additional information.

Audio Connections:

11. Connect Balanced Cables from the MAC7200 BALANCED INPUT L & R Connectors to the Media Server Audio Output Balanced Connectors.
12. Connect Audio Cables from the MAC7200 Number 1 UNBALANCED Jacks to the AM/FM Tuner UNBAL Output Jacks.
13. Connect the Audio Cables coming from the Turntable to the MAC7200 MC (for a Moving Coil Cartridge) or MM (for a Moving Magnet Cartridge) INPUT Jacks.
14. Optionally, connect Audio Cables from the MAC7200 OUTPUT 2 Jacks to the Power Amplifier (Secondary) Input Jacks.
15. Connect any additional Components in a similar manner, as outlined in steps 11 thru 14.

Optional Digital Audio Connections:

16. Connect an Optical Cable from the MAC7200 OPTICAL 1 Digital Audio Input Connector to the Digital Audio Out Optical Connector on the Digital Audio Player.

17. Using the “MCT Cable-Twisted Pair” cable (supplied with a MCT Transport), connect the cable from the MAC7200 MCT DIGITAL AUDIO INPUT Connector to the SACD/CD Transport MCT (DIN) Output Connector.
18. Connect any additional Components in a similar manner, as outlined in steps 17 thru 18.

Optional USB Connection:

19. Connect a USB cable with (Type A to Type B) connectors from the MAC7200 USB D/A Digital Audio Input to an available USB connector.

Antenna Connection:

20. Connect a FM Antenna (or Cable System) to the FM ANT 75 Ohm Connector.
21. Connect the supplied McIntosh RAA2 AM Antenna and connection cable to the RAA2 AM ANT Connector.

Ground Connections:

22. Connect the Ground Cable coming from the Turntable to the MAC7200 GND Binding Post.

Notes: 1. If the MAC7200 is part of a Home Theater System, proceed to “PassThru” connection on page 11.
 2. *When the MAC7200 will used together with a separate Power Amplifier for Bi Amplification of a Loudspeaker System, proceed page 12.*

Passthru Connections

The MAC7200 can be part of a Multichannel Sound System for BLU-RAY-Audio, DVD-Audio and Home Theater Movies. The Right and Left Front Channels from an Audio/Video Control Center can “Passthru” the MAC7200. In the following example the UNBALANCED 5 Input will become the “Passthru” input:

1. Connect Audio Cables from the A/V Processor FL (Front Left) and FR (Front Right) Channel Outputs to the MAC7200 UNBALANCED Number 5 INPUTS Left and Right Jacks.
2. Connect a Control Cable from the A/V Processor TRIGger 2 Output to the MAC7200 POWER CONTROL PASSTHRU INPUT Jack.

Note: Refer to Setup “Passthru” on page 23 to assign the Number 5 INPUT as the “Passthru” Input.

3. Proceed to “Connecting Loudspeaker” on Page 11.

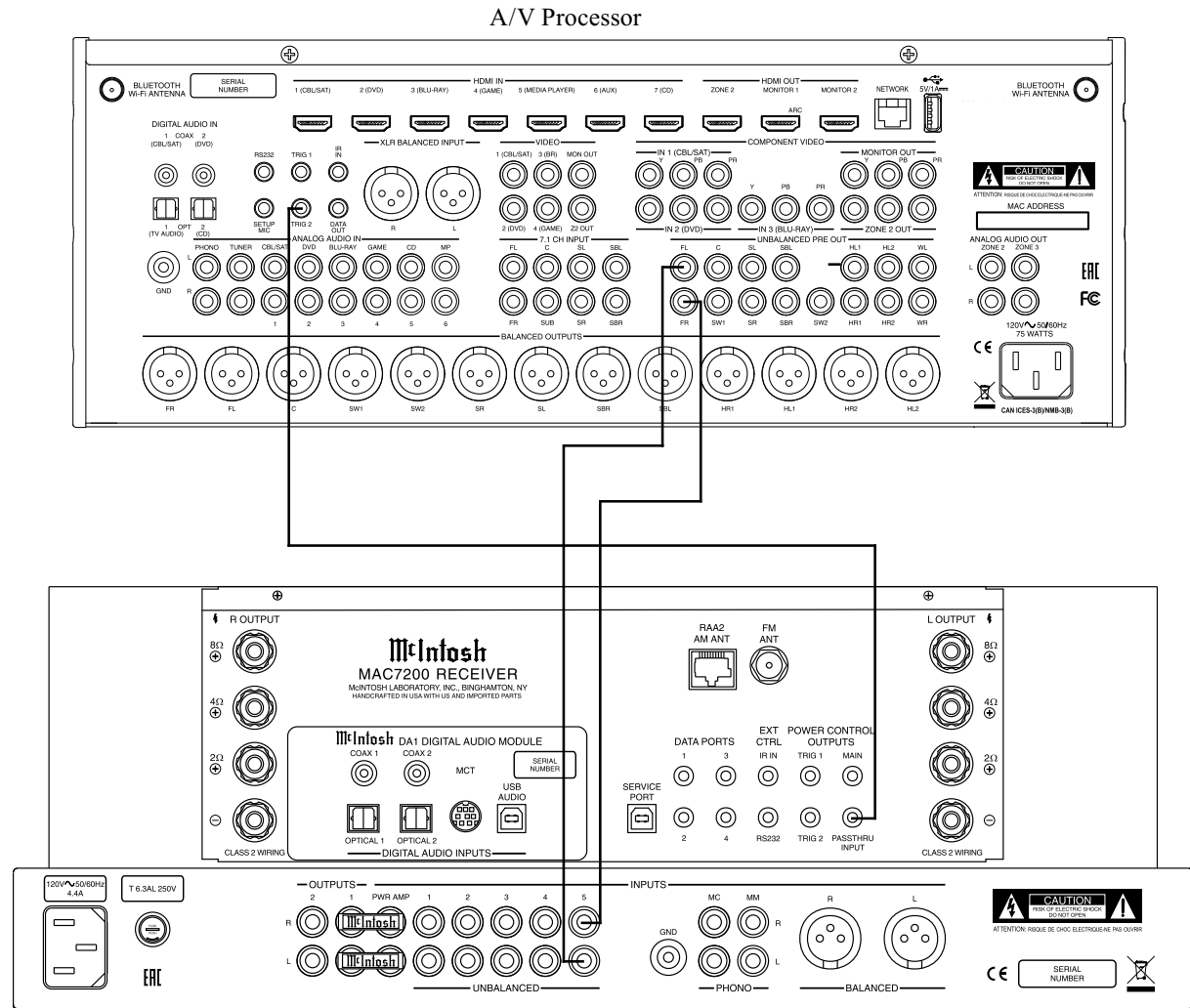

Connecting for Bi-Amplification

The MAC7200 Power Amplifier, together with an additional separate Power Amplifier, may be used to Bi-Amplify a Loudspeaker System. In the illustration on this page, the Power Amplifier of the MAC7200 is connected to the Midrange/High Frequency Section of the Loudspeaker. The additional separate Power Amplifier is connected to the Low Frequency Section of the Loudspeaker System.

Warning: The Loudspeaker System used for Bi-Amplification must have the jumpers removed from between the MID/HIGH and LOW Frequency Sections of the Loudspeaker System. Failure to remove them could result in damage to the MAC7200 and/or the separate Power Amplifier.

MAC7200 Connections:

1. Remove the “McIntosh Jumpers” from between the OUTPUT 1 Jacks and the PWR AMP In Jacks located on the Rear Panel of the MAC7200.
- Note: Place the “McIntosh Jumper” in a safe place for possible future use.*
2. Using a pair of shielded RCA Type Audio “Y” Adapters connect the OUTPUT 1 Jacks to the PWR AMP In Jacks, for both Left and Right Channels.
3. Connect the remaining unconnected part of the “Y” Adapters to the separate Power Amplifier.
4. Referring to the Loudspeaker Connection Instructions on page 13, and in the Owner’s Manual supplied with the Power Amplifier and Loudspeaker, connect the MAC7200 Output Terminals to the Loudspeaker MID/HIGH Input Terminals.

Note: The Loudspeaker Connection illustrations on this page are for the Left Channel. Connect the Right Channel Loudspeaker in the same manner.

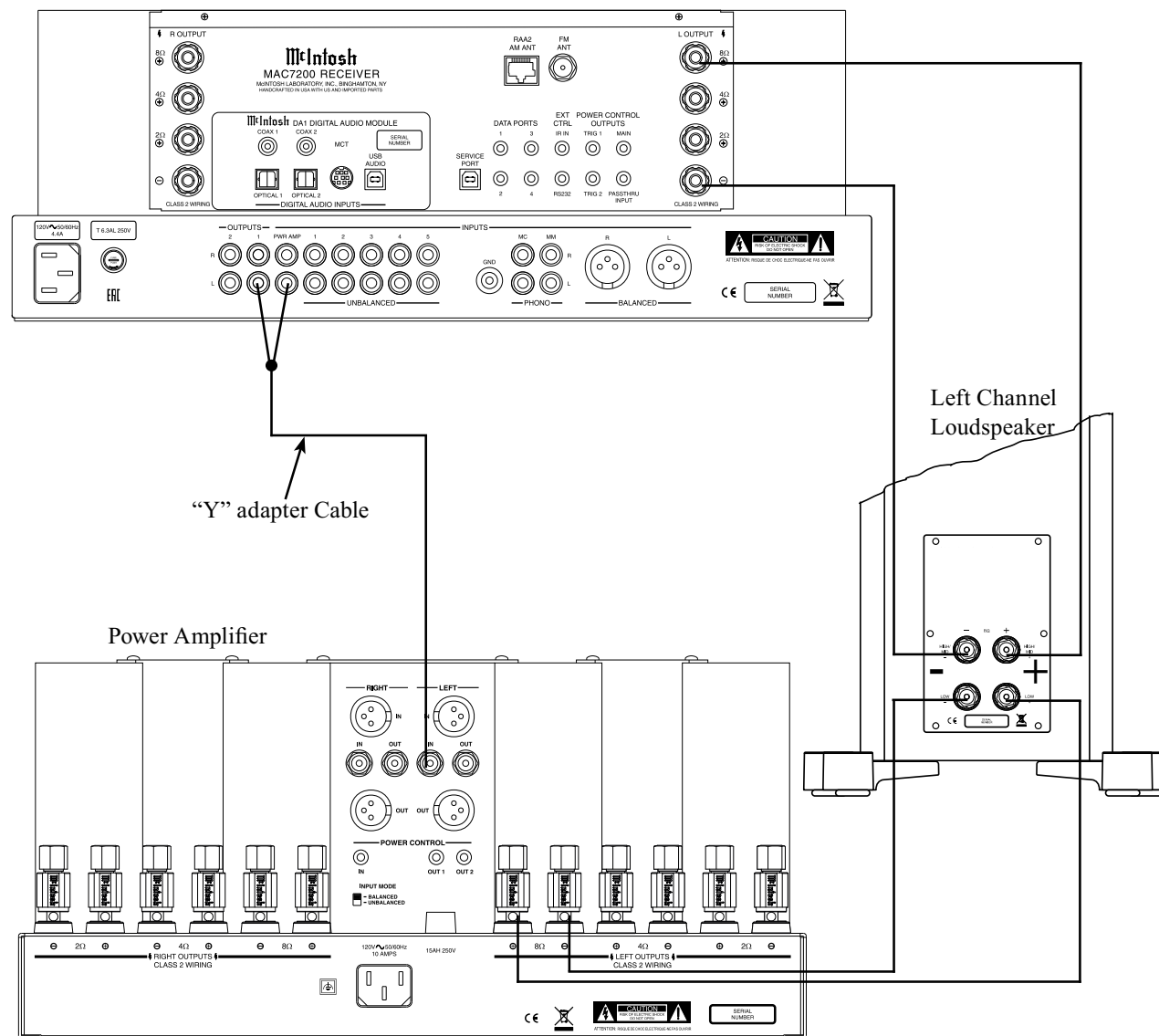

Output Terminals

When connecting the Loudspeaker Hookup Cables to the MAC7200 Amplifier Output Terminals please follow the steps below:

1. Rotate the top of the Output Terminal Post counterclockwise until an opening appears. Refer to figures A and B.
2. Insert the Loudspeaker hookup cable into the Output Terminal Post opening or the cable spade lug around the center post of the Output Terminal. Refer to figure C.
3. Rotate the top of the Output Terminal Post clockwise until it is finger tight. Refer to figure D.
4. Place the supplied McIntosh Wrench over the top of the Output Terminal and rotate it one quarter of a turn (90°) to secure the Loudspeaker Cable Connection. **Do not over tighten.** Refer to figure E.

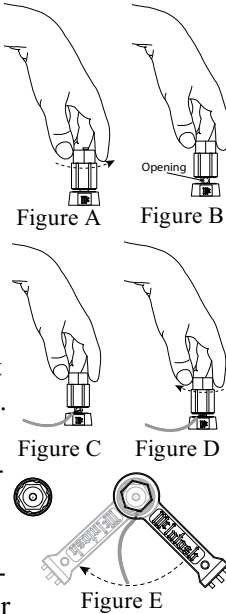

How to Connect Loudspeakers

Caution: Do not connect the AC Power Cord to the MAC7200 Rear Panel until after the Loudspeaker Connections are made. Failure to observe this could result in Electric Shock.

The connection instructions below, together with the MAC7200 Connection Diagram located on the separate folded sheet “Mc2B”, is an example of a typical audio system. Your system may vary from this, however the actual components would be connected in a similar manner. For additional information refer to “Connector and Cable Information” on page 4.

The McIntosh MAC7200 Power Amplifier Circuitry is designed for Loudspeakers with an impedance of 2 ohms, 4 ohms or 8 ohms. Connect a single Loudspeaker only to the Right and Left Output Terminals.

When connecting Loudspeakers to the MAC7200 it is very important to use cables of adequate size, so there is little to no power loss in the cables. The size is specified in Gauge Numbers or AWG (American Wire Gauge). The smaller the Gauge number, the larger the wire size:

Loudspeaker Cable Distance vs Wire Gauge Guide			
Loudspeaker Impedance	25 feet (7.62 meters) or less	50 feet (15.24 meters) or less	100 feet (30.48 meters) or less
2 Ohms	12AWG	10AWG	8AWG
4 Ohms	14AWG	12AWG	10AWG
8 Ohms	16AWG	14AWG	12AWG

1. Prepare the Loudspeaker Hookup Cable for attachment to the MAC7200 Power Amplifier:
 - Bare wire cable ends: Carefully remove sufficient insulation from the cable ends, refer to figures F, G & H. If the cable is stranded, carefully twist the strands together as tightly as possible.

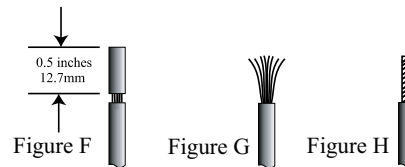

- Notes:
1. If desired, the twisted ends can be tinned with solder to keep the strands together.
 2. The prepared bare wire cable ends may be inserted into spade lug connectors.
 3. Banana plugs are for use in the United States and Canada only.

Banana Plugs are for use in the United States and Canada only:

2. Attach the previously prepared bare wire cable ends into the banana plugs and secure the connections. Refer to figure I.
3. Rotate the Output Terminal Post clockwise until it is finger tight. Refer to figure J. Then using the McIntosh Wrench, rotate the top of the Output Terminal one quarter of a turn (90°). **Do not over tighten.** Refer to figure E.
4. Referring to figure K, connect the Loudspeaker hookup cables with banana plugs into the hole at the top of the terminal to the MAC7200 Negative Output Terminal and Positive Output Terminal identified as 2Ω (ohms), 4Ω (ohms) or 8Ω (ohms) connection to match the impedance of the Loudspeaker, being careful to observe the correct polarities.

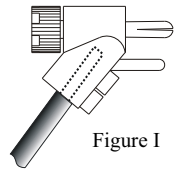

Figure I

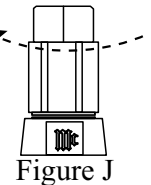

Figure J

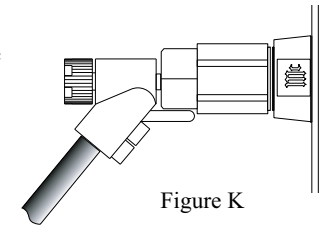

Figure K

Note: The illustration located on the separate folded sheet “Mc2B” is for connection to an 8Ω (ohms) Loudspeaker.

If the Loudspeaker’s impedance is in-between the available connections, use the nearest lower impedance connection. Refer to “General Information” Note 6 on page 3 for additional information.

WARNING: Loudspeaker terminals are hazardous live and present a risk of electric shock. For additional instruction on making Loudspeaker Connections contact your McIntosh Dealer or McIntosh Technical Support.

5. Connect the MAC7200 power cord to an active AC outlet.

Spade Lug or Wire Connections:

6. Connect the Loudspeaker hookup cables to the MAC7200 Negative Output Terminal and Positive Output Terminal indentified as 2Ω (ohms), 4Ω (ohms) or 8Ω (ohms) connection to match the impedance of the Loudspeaker, being careful to observe the correct polarities. Insert the spade lug connector or prepared section of the cable end into the terminal side access hole, and tighten the terminal cap until the cable is firmly clamped into the terminals so the lugs or wire cannot slip out. Refer to figures L and M.

Note: The illustration located on the separate folded sheet "Mc2B" is for connection to an 8Ω (ohms) Loudspeaker.

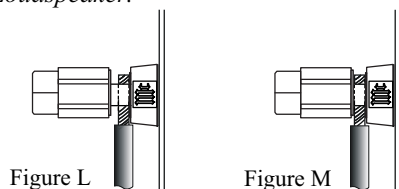

If the Loudspeaker's impedance is in-between the available connections, use the nearest lower impedance connection. Refer to "General Information" Note 6 on page 3 for additional information.

WARNING: Loudspeaker terminals are hazardous live and present a risk of electric shock. For additional instruction on making Loudspeaker Connections contact your McIntosh Dealer or McIntosh Technical Support.

7. Connect the MAC7200 power cord to an active AC outlet.



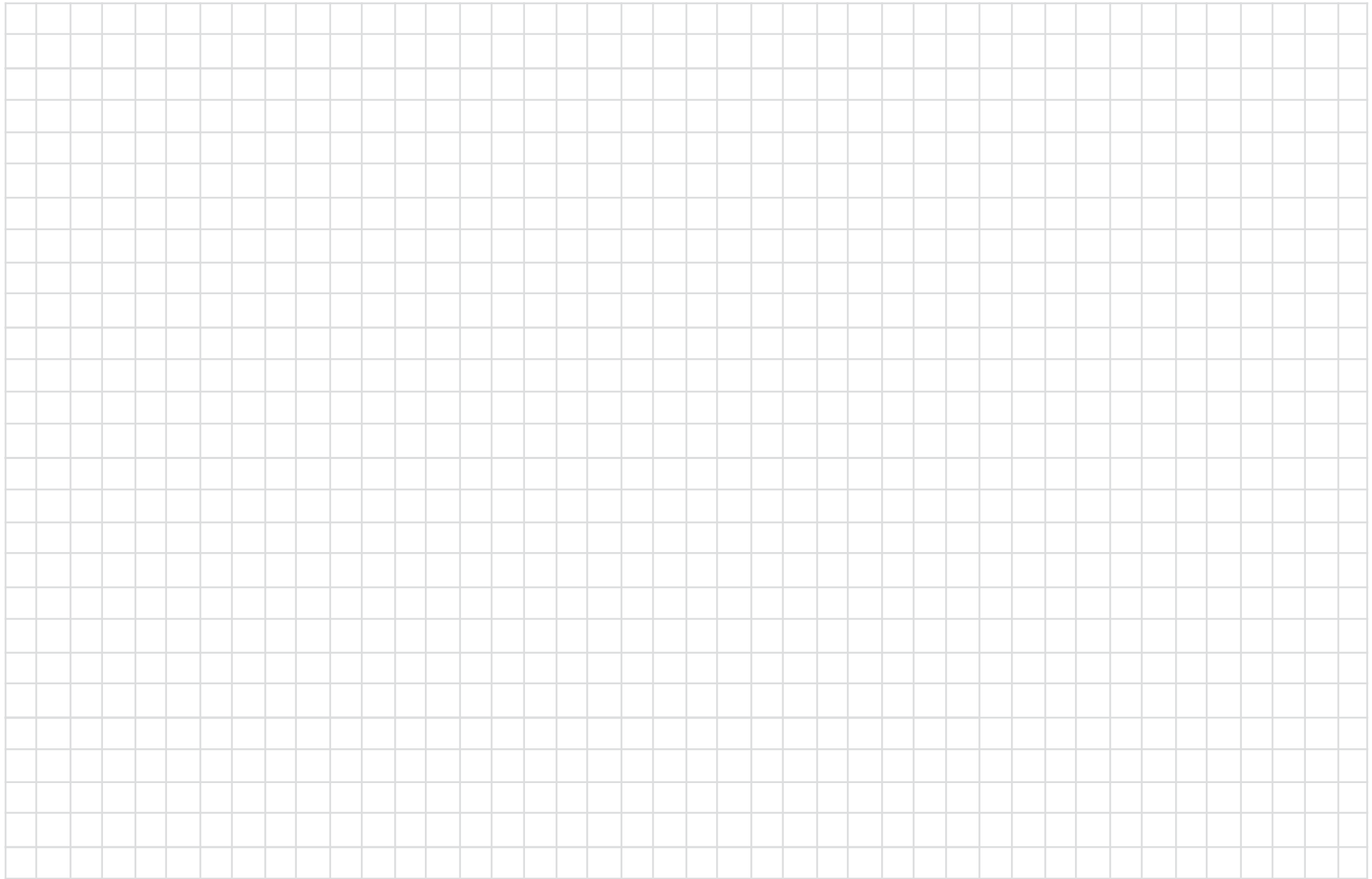



LEDs illuminate during the time a remote command is sent and when programming the remote control

Select the DEVICE to issue a remote control command to

SETUP Push-button is used as a "Shift Key" to select a function with blue color nomenclature

Selects AM Tuner Operating Functions, select Output 1 when used with the SETUP/shift Push-button and Track Selection on certain McIntosh CD Players

Press the Trim Push-button and then the LEVEL UP Push-button to select and adjust various functions. MENU is used with McIntosh Models displaying choices on a video screen

Activates the TRIM Mode. GUIDE is used with McIntosh Models displaying instructions on a video screen

Press the Trim Push-button and then the LEVEL DOWN Push-button to select and adjust various functions. INFO is used with McIntosh Models displaying information on a video screen

Scrolls through the available INPUTS

Mutes the audio

Selects transport functions of STOP, PLAY/PAUSE, RECORD, BACK for the previous-selection, FAST-REVERSE, FAST-FORWARD and NEXT for the next selection

Selects Previous Tuner Station PRESET

Tuner scans Down the dial to SEEK the next Station

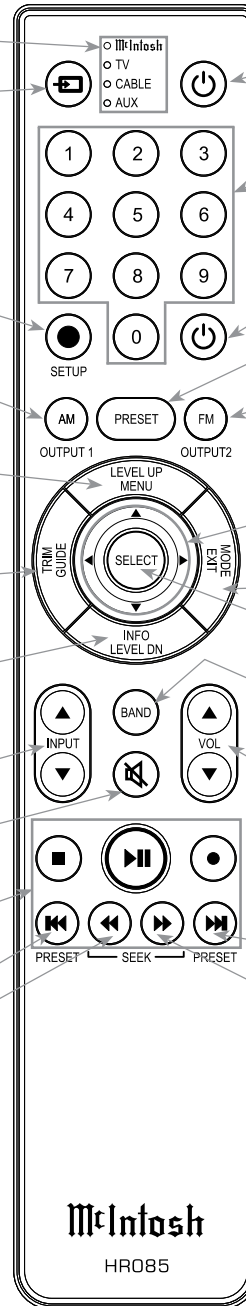

Press to Power the Integrated Amplifier ON

Use to select tuner presets, direct access an AM/FM Station Frequency, disc tracks or any numbered operation

Press to Power the Integrated Amplifier OFF

Direct access to stored Tuner PRESETS when used with the numeric Push-buttons (0 thru 9)

Selects FM Tuner Operating Functions, select Output 2 when used with the SETUP/shift Push-button and Track Selection on certain McIntosh CD Players

Use ▲ and ▼ to tune Up or Down the AM/FM Dial, use ► and ◀ for the next or previous HD Radio Program (were applicable)

EXIT the TRIM Menu and is used with McIntosh Models displaying information or choices on a video screen

Used to SELECT/Enter the indicated choice

Press to change Broadcast BANDS on a connected Tuner. Select certain functions on a variety of McIntosh Models

Adjusts the VOLUME level up or down

Selects Next Tuner Station PRESET

Tuner scans Up the dial to SEEK the next Station

Note: Push buttons whose function is not identified above are for use with other McIntosh Products.

How to use the Remote Control

The supplied MAC7200 Remote Control (HR085) is capable of directly controlling the functions of contemporary McIntosh Source Components connected to the MAC7200 via the Data Ports.

- Notes:*
1. If at any time the MAC7200 seems unresponsive to the HR085 Remote Control Commands, press the  DEVICE Push button to select **McIntosh** first.
 2. For additional information on using the HR085 Remote Control with the McIntosh Model, please refer to the "How to Operate" starting on page 28.
 3. For additional information on assigning the Data Ports, refer to "Data Ports" on page 23.

Trim

Press the TRIM Push-button until the desired Trim function (Balance, Trim Level, etc.) appears on the MAC7200 Front Panel Display, then press the LEVEL Up or Down Push-button to adjust the Trim setting.



Note: Press the TRIM Push button to recall the last Trim function selected. For additional information on using the Trim Functions refer to "How to Operate" page 28.



Output Selection

Press the BLUE (Setup) Push-button followed by the AM (Output 1) or FM (Output 2) Push-button, to control the Rear Panel Audio OUTPUTS 1, 2 (ON or OFF) and Power Control TRIG 1 / TRIG 2.

Note: For additional information on assigning the Outputs (1 and 2) and Power Control Triggers (1 and 2) refer to page 22.

Tuner Push-buttons

Press the AM or FM Push-button to select the desired broadcast band. Press and release the Seek Up  the band or Seek Down  the band Push-button to seek

the next available station. Press and hold a Directional Up  or Down  Push-button to tune continuously from station to station.





Front Panel Displays, Controls, Push-buttons and Jack

INPUT Control used to select a source for listening and recording. The control is also used to enter the TRIM or SETUP Modes and select the various functions

LED indicates when the Left Channel Amplifier POWER GUARD circuit activates

LED indicates when the Right Channel Amplifier POWER GUARD circuit activates

VOLUME Control allows adjustment of the listening level for both channels. Also used to change the various TRIM and SETUP Functions

Meter indicates the Left Channel Output of the amplifier

Meter indicates the Right Channel Output of the amplifier

Connection for low impedance dynamic headphones, for private listening

PRESET Control selects Presets for listening or storing the desired radio station

INFORMATION DISPLAY indicates the Sources, Volume, other Audio Settings, Tuner Functions, other Operational Functions and Setup Mode Settings

TONE Push-button with indicator, when deactivated the audio signal bypasses the Tone Settings

TUNE tunes in radio stations and is also used for various Tuner Functions

OUTPUT 1 and 2 Push-buttons with indicators, switch Preamplifier Output (Loudspeakers) 1 and 2 On or Off

IR Sensor receives commands from a Remote Control

MUTE Push-button mutes the audio from the Loudspeakers and Headphones

STANDBY/ON Push-button with indicator switches the MAC7200 ON or OFF (Standby) and resets the microprocessors

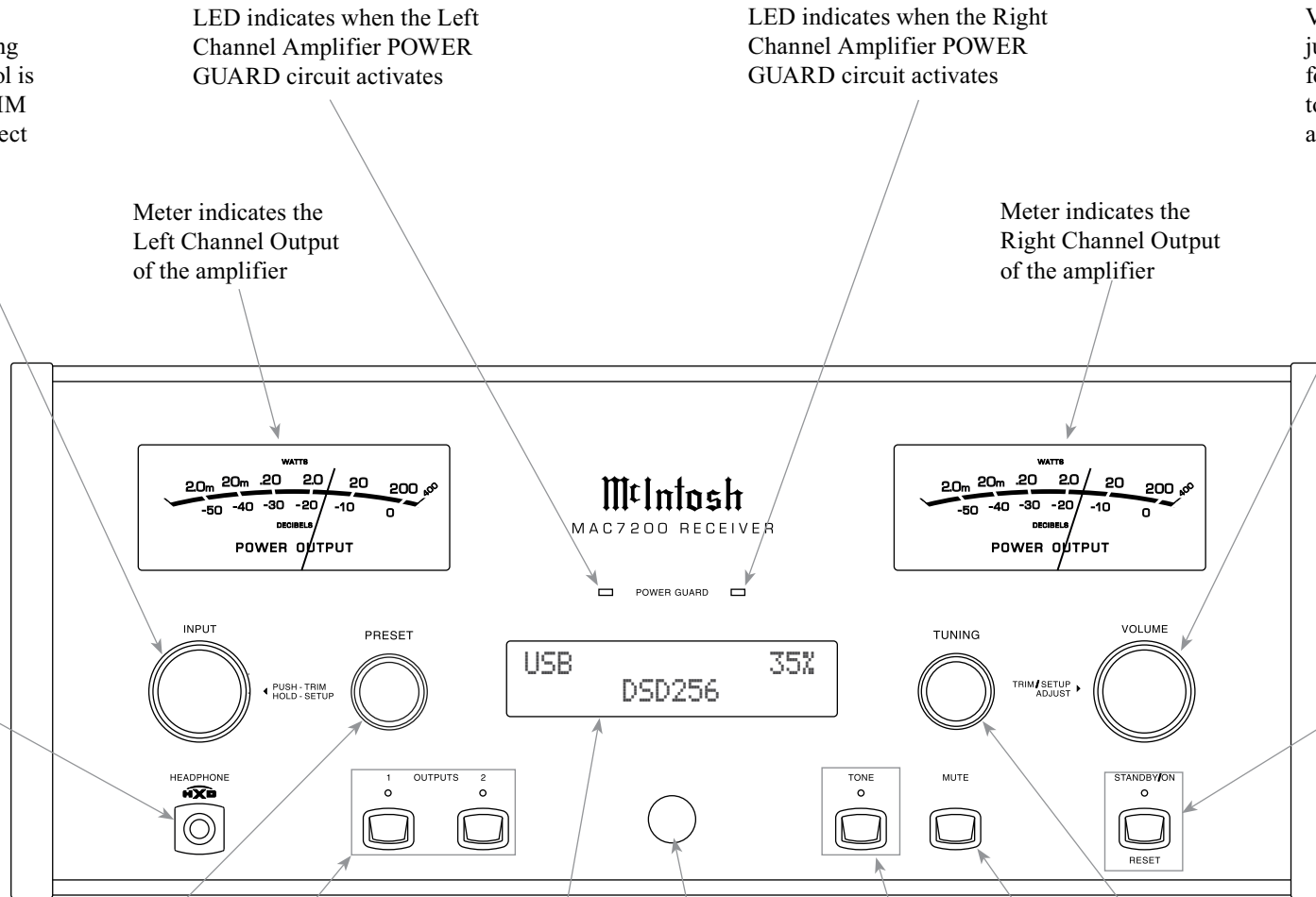

How to Operate the Setup Mode

Your McIntosh MAC7200 has been factory configured to allow immediate enjoyment of superb audio without the need for further adjustments. If you wish to make changes to the factory default settings, a Setup Feature is provided to customize the operating settings using the Front Panel Information Display. Refer to the MAC7200 Front Panel Illustration on the previous page while performing the following steps.

Note: If the MAC7200 is currently On, proceed to step 2.

1. Press the STANDBY/ON Push-button on the Front Panel or press the  (Power ON) Push-button on the Remote Control to switch On the MAC7200. The MAC7200 will go through a brief startup initialization with the Front Panel Information Display first indicating "MAC7200", followed by the last used source and volume setting. This is followed by the volume setting indication starting at zero and then increasing to the last used volume setting. Refer to figure 1.



Figure 1

2. Press and hold in the INPUT Control until the Front Panel Information Display indicates "MAC7200 V1.00, (or higher Main Firmware version) - S/N: AFN ____" (Serial Number). Refer to figure 2.



Figure 2

3. Rotate the INPUT Control to select the Setup Mode Menu item, "SETUP: Inputs, (Hold INPUT)". Refer to figure 3.



Figure 3

Continue to rotate the INPUT CONTROL to view the other SETUP Mode Options.

4. To exit from the SETUP Mode, press and hold in the INPUT Control and the Front Panel Display will indicate its normal display. Refer to figure 1.

Default Settings

The Default Settings Chart below indicates the Function Name, Default Setting and the Page Number for additional information.

Default Settings		
Function Name	Setting	Page No.
MAC7200	V .	19
DA1	V .	19
TUNER FIRMWARE	TM	19
INPUTS	On / Rename	20
OUTPUTS (1 & 2)	Switched	20
TRIGGER 1	Output 1	20
TRIGGER 2	Output 2	20
DATA PORTS (1 thru 4)	All Data	20
PASSTHRU	OFF	21
USB Automute	ON	21
RS232 (Rate)	115200 Baud	21
Remote Control Codes	Normal	21
IR Sensor	Enabled	22
Power Mode	Enabled	22
Tuner Presets		25
Tuner Region	USA	26

Firmware Version

The MAC7200 functionality is controlled by internal software that is known as Firmware. There are three Firmware Identification Numbers for the MAC7200. The first Firmware Number is for the Main Circuitry of the MAC7200 and can be identified at any time by utilizing the Setup Mode.

1. Press and hold in the INPUT Control to enter Setup Mode.
2. Referring to the Front Panel Information Display—the number after the character "V" is the Firmware number. Refer to figure 2.

To view the second Firmware Number (the Digital Audio Circuitry of the MAC7200) or the third Firmware Number (the Tuner Circuitry of the MAC7200), perform the following steps:

3. Press and hold in the INPUT Control to enter Setup Mode.
4. Rotate the INPUT Control until the Front Panel Information Display indicates "DA1 Firmware, V1.00" (or higher Digital Audio Firmware version). Refer to figure 4.



Figure 4

4. Rotate the INPUT Control until the Front Panel Information Display indicates "TUNER FIRMWARE Firmware, V1.00" (or higher Digital Audio Firmware version). Refer to figure 5.

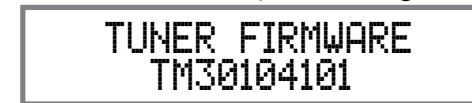

Figure 5

5. To exit the Setup Mode, press the INPUT Control.



Input Settings

The MAC7200 provides the ability to switch unused INPUTS Off (or back On if they have been previously switched Off). The default INPUT Names can be changed to match the name of the component connected to it or any other custom name desired (within 10 Characters).

INPUT SWITCHED ON/OFF:

In the following example, the UNBAL 4 Input will be switched Off.

Note: When an INPUT is switched Off, its name will no longer appear on the Front Panel Information Display when using the INPUT Control (Front Panel or Remote Control).

1. Press and hold in the INPUT Control to enter the SETUP MODE. Refer to figure 2 on page 19.
2. Rotate the INPUT Control until “SETUP: Inputs, (Hold INPUT)” appears on the Information Display. Refer to figure 3 on page 19.
3. Press and hold in the INPUT Control until “SETUP: UNBAL 4, On / Name (Hold INPUT)” appears on the Display. If necessary rotate the INPUT Control to select the UNBAL 4 Input. Refer to figure 6.

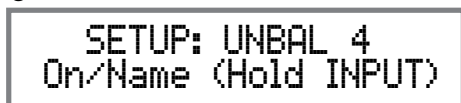

Figure 6

4. To switch the UNBAL 4 Input Off, rotate the VOLUME Control until the display indicates “SETUP: UNBAL 4, Off”. Refer to figure 7.



Figure 7

5. Exit the SETUP Mode by several presses of the INPUT Control.

In the following example, the UNBAL 4 Input will be switched On.

Notes: 1. When a desired INPUT is selected, its name will appear on the Front Panel Information Display when using the INPUT Control (Front Panel or Remote Control).

6. Press and hold in the INPUT Control to enter the SETUP MODE. Refer to figure 2, on page 19.
7. Rotate the INPUT Control until “SETUP: Inputs, (Hold INPUT)” appears on the Information Display. Refer to figure 3, on page 19.
8. Press and hold in the INPUT Control until “SETUP: UNBAL 4, Off” appears on the Display. If necessary rotate the INPUT Control to select the UNBAL 4 Input. Refer to figure 7.
9. To switch the UNBAL 4 Input On, rotate the VOLUME Control until the display indicates “SETUP: UNBAL 4, On / Name”.
10. Exit the SETUP Mode by several presses of the INPUT Control.

RENAME INPUT:

In the following example, the BAL (BALANCED) Input will be renamed to match up with the component connected (refer to page 10, step 11).

The MAC7200 Default Input Names (UNBAL 1, BAL, COAX 1, etc.) as indicated on the Front Panel Display can be customized to a different name up to ten characters long (TUNER, CD PLAYER, etc.). The available characters for renaming the input include the following: ! < > * , / - 0 1 2 3 4 5 6 7 8 9 A B C D E F G H I J K L M N O P Q R S T U V W X Y Z .

In the following example, the BAL Input will be renamed to “MEDIA SVR”.

11. Press and hold in the INPUT Control to enter the SETUP MODE. Refer to figure 2, on page 19.
12. Rotate the INPUT Control until “SETUP: Inputs,

(Hold INPUT)” appears on the Information Display. Refer to figure 8.

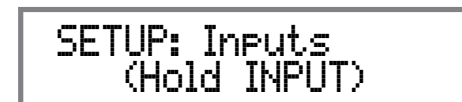

Figure 8

13. Press and hold in the INPUT Control until “SETUP: BAL, On / Rename” appears on the Display. If necessary rotate the INPUT Control to select the BAL Input. Refer to figure 9.

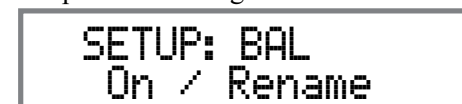

Figure 9

14. Press and hold in the INPUT Control until “RENAME: BAL, >BAL <” appears on the Display. The character “B” is flashing to indicate it is ready to be changed. Refer to figure 10.



Figure 10

15. Rotate the VOLUME (ADJUST) Control to change the character “B” to “M”. Refer to figure 11.



Figure 11

16. Rotate the INPUT Control until the character “A” is flashing, then rotate the VOLUME (ADJUST) Control to change the character “A” to “E”. Refer to figure 12.



Figure 12

17. Rotate the INPUT Control until the character “L” is flashing, then rotate the VOLUME (ADJUST) Control to change the character “L” to “D”. Refer to figure 13.



Figure 13

18. Rotate the INPUT Control until the “ ” empty space to the right of character D is flashing, then rotate the VOLUME (ADJUST) Control to change the “ ” empty space to character to “I”. Refer to figure 14.



Figure 14

19. Rotate the INPUT Control until the “ ” empty space to the right of character I is flashing, then rotate the VOLUME (ADJUST) Control to change the “ ” empty space to character to “A”. Refer to figure 15.



Figure 15

20. Repeat step 19 until the new name of “RENAME: BAL, MEDIA SVR” is indicated on the Front Panel Display. Refer to figures 16 thru 18.



Figure 16



Figure 17



Figure 18

21. To save the new name, press and hold in the INPUT Control until “SETUP: MEDIA SVR , ON / Rename” appears on the Front Panel Information Display. Refer to figure 19.



Figure 19

22. Exit the SETUP Mode by several presses of the INPUT Control.

Note: For convenience, an “Input Assignment Chart” on a separate sheet “Mc5A/5B” has been provided to keep track of changes.

Output Settings

The Output Settings provide the ability to change how the MAC7200 Output 1, Output 2 and Headphones function.

OUTPUT 1 and 2:

By default OUTPUT 1 and 2 are set to go On/Off by using the Front Panel OUTPUT 1 and 2 Push-buttons or by using the OUTPUT 1 and 2 Push-buttons on the Remote Control. If it is desirable to have OUTPUT 1 and/or 2 always On regardless of the OUTPUT 1 and 2 Push-button settings, perform the following:

1. Press and hold in the INPUT Control to enter the SETUP MODE. Refer to figure 2 on page 19.
2. Rotate the INPUT Control until “SETUP: Outputs, (Hold INPUT)” appears on the Information Display. Refer to figure 20.
3. Press and hold in the INPUT Control until

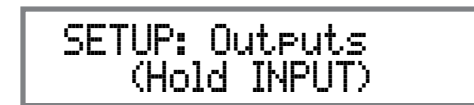

Figure 20

“SETUP: OUTPUT 1, Switched” appears on the Display. Refer to figure 21.



Figure 21

4. Rotate the VOLUME (ADJUST) Control to change from the “Switched” setting to “Unswitched”. Refer to figure 22.



Figure 22

5. In a similar manner, perform steps 3 and 4 to change the OUTPUT 2 setting. Refer to figures 23 and 24.



Figure 23

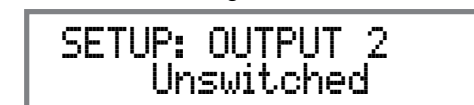

Figure 24

The MAC7200 Default Setting for using Headphones is to automatically mute all the Output Connectors when the Headphone Cable Plug is inserted into the MAC7200 Front Panel HEADPHONES Jack. There are two available settings:

- Mute All Outputs
- Mute No Outputs

6. Rotate the INPUT Control until “SETUP: HEAD-

Output Settings, con't

PHONES, Mute All Outputs” appears on the Information Display. Refer to figure 25.

Figure 25

7. Rotate the VOLUME (ADJUST) Control to change the current HEADPHONES setting from “Mute All Outputs” to “Mute No Outputs”. Refer to figure 26.

Figure 26

8. Exit the SETUP Mode by several presses of the INPUT Control.

Power Control Triggers 1 and 2

By default the Power Control TRIGGER 1 and TRIGGER 2 are assigned to activate when Output 1 or Output 2 is selected. Triggers 1 and 2 can be reassigned to function the same as the MAIN Power Control Jack or be assigned to a given Input.

Note: The MAIN Power Control Jack is controlled by the STANDBY/ON Front Panel Push button and the Remote Control Power Push buttons.

In the first example, the Power Control Triggers 1 and 2 will be assigned to MAIN:

1. Press and hold in the INPUT Control to enter the SETUP MODE. Refer to figure 2 on page 17.
2. Rotate the INPUT Control until “SETUP: Triggers, (Hold INPUT)” appears on the Information Display. Refer to figure 27.

Figure 27

3. Press and hold in the INPUT Control until “SETUP: TRIGGER 1, Output 1” appears on the Display. Refer to figure 28.

Figure 28

4. Rotate the VOLUME (ADJUST) Control to select “MAIN” from the available additional selections including Output 2 or Input. Refer to figure 29.

Figure 29

5. In a similar manner, perform steps 3 and 4 to change the Trigger 2 setting from OUTPUT 2 to Main. Refer to figures 30 and 31.

Figure 30

Figure 31

In the second example, Trigger 2 will activate when the BAL Input is selected:

6. Rotate the INPUT Control to select “SETUP: TRIGGER 2, Main” appears on the Display. Refer to figure 30.
7. Rotate the VOLUME (ADJUST) Control until “SETUP: TRIGGER 2, Input (Hold INPUT)” appears on the Display. Refer to figure 32.

Figure 32

8. Press and hold in the INPUT Control until “SETUP: TRIGGER 2, Bal: OFF” appears on the Display. Refer to figure 33.

Figure 33

9. Rotate the VOLUME (ADJUST) Control to select “Bal : ON”. Refer to figure 34.

Figure 34

10. Exit the SETUP Mode by several presses of the INPUT Control.

Data Ports

Data Port Connections between the MAC7200 and a McIntosh Source Component allow for basic function control of the source component using the MAC7200 supplied HR085 Remote Control. By default, all of the four Data Ports are set to send the same Data to the selected source. To dedicate a given Data Port for only one source component (example, source component connected to the BAL Input will be assigned to Data Port 1) perform the following Steps:

1. Press and hold in the INPUT Control to enter the SETUP MODE. Refer to figure 2 on page 17.
2. Rotate the INPUT Control until "SETUP: Data Ports, (Hold INPUT)" appears on the Information Display. Refer to figure 35.



SETUP: Data Ports
(Hold INPUT)

Figure 35

3. Press and hold in the INPUT Control until "SETUP: DATA PORT 1, All Data" appears on the Display. Refer to figure 36.



SETUP: DATA PORT 1
All Data

Figure 36

4. Rotate the VOLUME (ADJUST) Control to select the "BAL" Input. Refer to figure 37.



SETUP: DATA PORT 1
BAL

Figure 37

5. In a similar manner, perform steps 3 and 4 to assign any additional Data ports.
6. Exit the SETUP Mode by several presses of the INPUT Control.

Passthru

When the MAC7200 is part of a Home Theater or Multichannel Audio System the Right and Left Front Channels from an Audio/Video Processor or Surround Decoder can "Passthru" from the assigned MAC7200 Input, into the MAC7200 Power Amplifier Circuitry. The "Passthru" Audio Signal is also available for a separate external Power Amplifier(s) via the number 1 Preamplifier Output Jacks. The Setup Mode allows selection of the specified MAC7200 Input to be used for the Right and Left Front Channels. In the example below, the Right and Left Front Channels from the Audio/Video Processor will be connected to the UNBALANCED 6 INPUT Jacks on the MAC7200. Refer to page 9 for additional connection information.

Note: The Phono and Digital Inputs are not assignable as a Passthru Input.

1. Press and hold in the INPUT Control to enter the SETUP MODE. Refer to figure 2 on page 17.
2. Rotate the INPUT Control until "SETUP: Passthru, Off" appears on the Information Display. Refer to figure 38.



SETUP: Passthru
Off

Figure 38

3. Rotate the VOLUME (ADJUST) Control to select "SETUP: Passthru, UNBAL 6" Input. Refer to figure 39.



SETUP: Passthru
UNBAL 6

Figure 39

4. Exit the SETUP Mode by several presses of the INPUT Control.

USB Automute

The USB Automute Feature helps to ensure noise free playback of streaming music via the MAC7200 USB Input, as the Digital Audio Signal format changes (PCM, DSD, etc.). On occasion due to the way a Digital Audio Music Recording was made, it may become desirable to switch Off the USB Automute Feature. To switch Off Automute, perform the following steps:

1. Press and hold in the INPUT Control to enter the SETUP MODE. Refer to figure 2 on page 17.
2. Rotate the INPUT Control until "SETUP: USB Automute, ON" appears on the Information Display. Refer to figure 40A.



SETUP: USB Automute
ON

Figure 40A

3. Rotate the VOLUME (ADJUST) Control to select "SETUP: USB Automute, OFF" Input. Refer to figure 40B.



SETUP: USB Automute
OFF

Figure 40B

4. Exit the SETUP Mode by several presses of the INPUT Control.



Comm Port Baud Rate

The MAC7200 may be remotely controlled from other equipment connected to the Rear Panel RS232 Jack. The speed at which the MAC7200 communicates (8 bit, no parity and 1 stop bit) with other equipment is adjustable from 9,600 bits per second to 115,200 bits per second. To change from the default speed of 115,200 bits per second, perform the following steps:

1. Press and hold in the INPUT Control to enter the SETUP MODE. Refer to figure 2 on page 17.
2. Rotate the INPUT Control until “SETUP: RS232, 115200 Baud” appears on the Information Display. Refer to figure 41.



SETUP: RS232
115200 Baud

Figure 41

3. Rotate the VOLUME (ADJUST) Control to select the desired Baud Rate Speed.
4. Exit the SETUP Mode by several presses of the INPUT Control.

Remote Control Codes

The HR085 Remote Control included with the MAC7200 utilizes the NORMAL McIntosh Control Codes. The Second Set of Control Codes the MAC7200 will respond to is referred to as the ALTERNATE Codes. The Alternate Codes are used when the MAC7200 is used in the same location as another McIntosh Preamplifier and/or A/V Processor. This will prevent the Remote Control from affecting the operation of both units at the same time. To activate the Remote Control ALTERNATE Codes perform the following steps:

1. Press and hold in the INPUT Control to enter the SETUP MODE. Refer to figure 2 on page 17.
2. Rotate the INPUT Control until “SETUP: IR Codes, Normal” appears on the Information Display. Refer to figure 42.



SETUP: IR Codes
Normal

Figure 42

3. Rotate the VOLUME (ADJUST) Control to the Alternate Codes. Refer to figure 43.



SETUP: IR Codes
Alternate

Figure 43

4. It is now necessary to change the HR085 Remote Control over to the Alternate Codes. Information on the HR085 Remote Control is available for download from the McIntosh Web Site:
<http://www.mcintoshlabs.com/us/Products/pages/ProductDetails.aspx?CatId=preamplifiers&ProductId=MAC7200>
5. Exit the SETUP Mode by several presses of the INPUT Control.

IR Sensor

The MAC7200 Front Panel Sensor, which receives the signals from the HR085 Remote Control, can be switched off to prevent interference when an external IR Sensor is connected. To de-activate the Front Panel IR Sensor perform the following steps:

1. Press and hold in the INPUT Control to enter the SETUP MODE. Refer to figure 2 on page 17.
2. Rotate the INPUT Control until “SETUP: Front IR, Enabled” appears on the Information Display. Refer to figure 44.



SETUP: Front IR
Enabled

Figure 44

3. Rotate the VOLUME (ADJUST) Control to select Disabled. Refer to figure 45.



SETUP: Front IR
Disabled

Figure 45

5. Exit the SETUP Mode by several presses of the INPUT Control.

Power Mode

The MAC7200 incorporates an Auto Off Feature, which automatically places the preamplifier into the Power Saving Standby/Off Mode. This occurs approximately 30 minutes after there has been an absence of user activity (includes changes to any of the Operation Functions such as source selection, volume adjustment, etc.) or absence of an audio signal. If it is desirable to disable the Auto Off Feature perform the following steps:

1. Press and hold in the INPUT Control to enter the SETUP MODE. Refer to figure 2 on page 17.
2. Rotate the INPUT Control until "SETUP: Auto Off, Enabled" appears on the Information Display. Refer to figure 46.



SETUP: Auto Off
Enabled

Figure 46

3. Rotate the VOLUME (ADJUST) Control to select Disabled. Refer to figure 47.



SETUP: Auto Off
Disabled

Figure 47

4. Press the INPUT Control to exit the Setup Mode.

Tuner Presets

The MAC7200 AM/FM Tuner Setup Mode allows for adding and deleting Radio Station Presets. For detailed information about the MAC7200 Tuner Operation, including the easier way of entering and removal of Radio Station Presets refer to "How to Operation" the Tuner Functions on pages 33 and 34.

ENTERING PRESETS:

Follow the steps below for entering a Radio Station into Preset Memory for quick recall:

1. Press and hold in the INPUT Control to enter the SETUP MODE. Refer to figure 2 on page 17.
2. Rotate the INPUT Control until "SETUP: Tuner Presets, (Hold INPUT)" appears on the Information Display. Refer to figure 48.



SETUP: Tuner Presets
(Hold INPUT)

Figure 48

3. Press and hold in the INPUT Control until "FM Presets Set, (Hold INPUT)" appears on the Information Display. Refer to figure 49.



FM Presets Set
(Hold INPUT)

Figure 49

Note: To enter AM Presets instead of FM Presets, rotate the INPUT Control until the Information Display indicates "AM Presets Set, (Hold INPUT). then continue with step 4.

4. Press and hold in the INPUT Control until "P1 = Open, (Hold INPUT to SAVE)" appears on the Information Display. Refer to figure 50.



P1 = Open
(Hold INPUT to SAVE)

Figure 50

Note: If Presets were previously entered, the frequency of the station will appear in place of the word "Open".

5. Rotate the Front Panel TUNING knob to choose the radio station to be entered as P1 (Preset Number 1). Refer to figure 51.



P1 = 89.3 MHz
(Hold INPUT to SAVE)

Figure 51

6. To save FM Station 89.3Mhz as P1 Press and Hold in the Input Control. Refer to figure 52.



P1 = 89.3 MHz
PRESET SAVED

Figure 52

7. To enter additional Radio Station Presets, first rotate the PRESET Control until another Preset (P2 thru P20) with the word "Open" appears. Then using the TUNING knob find the next station to be entered as a Preset.

DELETING PRESETS:

Follow the steps below for deleting all the previously entered a Radio Station Presets from Memory:

1. Press and hold in the INPUT Control to enter the SETUP MODE. Refer to figure 2 on page 17.
2. Rotate the INPUT Control until "SETUP: Tuner Presets, (Hold INPUT)" appears on the Information Display. Refer to figure 53 on the next page.



Tuner Presets, con't

SETUP: Tuner Presets
(Hold INPUT)

Figure 53

3. Press and hold in the INPUT Control until “FM Presets Erase ALL, (Hold INPUT)” appears on the Information Display. Refer to figure 54.

FM Presets Erase ALL
(Hold INPUT)

Figure 54

Note: To delete AM Presets instead of FM Presets, rotate the INPUT Control until the Information Display indicates “AM Presets Erase All, (Hold INPUT)”, then continue with step 4.

4. Press and hold in the INPUT Control until “FM Presets Erase ALL, FM PRESETS ERASED” appears on the Information Display. Refer to figure 55.

FM Presets Erase ALL
FM PRESETS ERASED

Figure 55

5. Press the INPUT Control to exit the Setup Mode.

Tuner Regions

The MAC7200 Tuner is capable of receiving AM/FM Broadcasts in various parts of the world. The Broadcasters may use slightly different standards and the MAC7200 accommodates these differences.

Setting	AM Band	FM Band	FM Spacing
USA	530kHz - 1710kHz	87.9MHz - 107.9MHz	200kHz
JAPAN	522kHz - 1611kHz	76MHz - 90MHz	100kHz
EUR 100	522kHz - 1602kHz	87.5MHz - 108MHz	100kHz
EUR 50	522kHz - 1602kHz	87.5MHz - 108MHz	50kHz

The Tuner Region Default Setting is for the USA. To change the MAC7200 for the broadcast standards in your country follow the steps below:

Notes: 1. For additional information contact your McIntosh Dealer.

2. Changing the current Tuner Region will result in clearing of all the Station Presets.

1. Press and hold the INPUT CONTROL until the Front Panel Display indicates the Setup Mode is active. Refer to figure 2 on page 17.
2. Rotate the INPUT Control until “SETUP: Tuner Region, (Hold INPUT)” is indicated. Refer to figure 56.

SETUP: Tuner Region
(Hold INPUT)

Figure 56

3. Rotate the INPUT Control until “SETUP: Tuner Region, USA” is indicated. Refer to figure 57.

SETUP: Tuner Region
USA

Figure 57

In the following example, the Tuner Region Setting of USA will be changed to JAPAN:

4. Rotate the VOLUME Control to select the JAPAN Region. Refer to figure 58.

SETUP: Tuner Region
JAPAN

Figure 58

5. Momentarily press the INPUT Control to set the new region. Refer to figure 59.

Set Region: JAPAN?
(SAVE: Press Input)

Figure 59

6. Momentarily press the INPUT Control to set the new region. Refer to figure 60.

Set Region: JAPAN
--SAVED--

Figure 60

7. Press the INPUT Control to exit the Setup Mode.

Factory Reset

If it becomes desirable to reset all the adjustable settings (Setup and Trim Settings) to the factory default values, perform the following steps:

1. Press and hold in the INPUT Control to enter the SETUP MODE. Refer to figure 2 on page 17.
2. Rotate the INPUT Control until “FACTORY RE-SET, (Hold INPUT)” appears on the Information Display. Refer to figure 61.



Figure 61

3. Press and hold in the INPUT Control until “FACTORY RESET, In Progress!” appears on the Information Display, then release the INPUT Control. Refer to figures 62 and 63.



Figure 62



Figure 63

4. Press the Front Panel STAND/BY Push-button to switch On the MAC7200.

Reset of the Microprocessors

In the unlikely event the controls of the MAC7200 stop functioning, the microprocessors can be reset by performing the following:

1. Press the STANDBY/ON Push-button until the STANDBY/ON LED Indicator switches Off.
2. Then release the STANDBY/ON Push-button and the MAC7200 will switch Off.
3. When the STANDBY/ON LED is illuminated press the STANDBY/ON Push-button, the MAC7200 will resume normal operation.



Note: This can be performed with the MAC7200 On or in the Standby Mode.





How to Operate the MAC7200

Power On and Off

The Red LED above the STANDBY/ON Push-button lights to indicate the MAC7200 is in Standby mode. To switch ON the MAC7200, Press the STANDBY/ON Push-button on the Front Panel or press the  (Power - Green) Push-button on the Remote Control. The MAC7200 will go through a brief startup initialization with the Front Panel Display indicating Power Guard is active, last used source and volume setting. This is followed by the volume setting indication starting at zero and then increasing to the last used volume setting. Refer to figures 70, 71, 72 and 73. To switch OFF the MAC7200, press the STANDBY/ON Push-button on the Front Panel or the  (Power - Red) Push-button on the Remote Control.

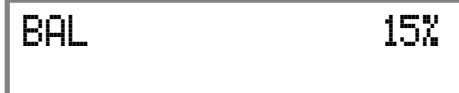

Figure 71

Note: For an explanation of the Remote Control Push button functions, refer to pages 16 and 17.

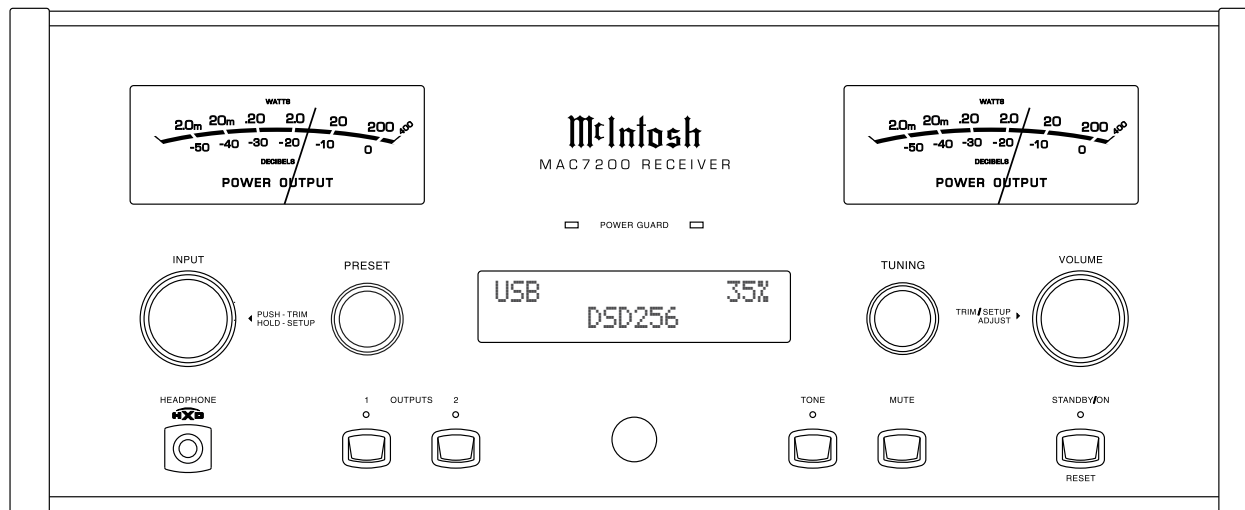

Figure 70



Figure 72

Source Selection

Rotate the INPUT Control to select the desired source or press the INPUT Up▲ or Down▼ Push-button on the Remote Control. Refer to figures 70 and 73.

Volume Control

Rotate the Front Panel VOLUME Control or use the VOLume Up▲ or Down▼ Push-buttons on the Remote Control for the desired listening level. Refer to figures 70 and 73.

Trim Functions

The MAC7200 has various Trim Selections with Adjustments. The Trim Functions include Balance, Input Trim Level, Tone Controls, Bass, Treble, Tuner Con-

trol (when the Tuner FM or Tuner AM is Selected), Phono Cartridge MC Loading (when the Input is Selected), Mono/Stereo, Meter Backlight, Display Brightness and HXD Mode (when Headphones are connected). The Trim Settings are stored in memory independently for each Input Source Selected, except the Meter Illumination and Digital Audio Display settings of On or Off, which are the same for all inputs.

Note: Selection and Adjustment of all Trim Functions may be performed by pressing the Front Panel INPUT Trim Control and then rotating it to select the desired Trim Function. Then use the VOLUME Adjust Control to change the setting. Remote Control TRIM Push Button together with the LEVEL UP/Down Push button may also be used. Refer to figures 70 and 73.

After approximately 5 seconds the Display returns to indicate the Source Selection and Volume Level.

BALANCE

Listening balance varies with different program sources, room acoustics and listening positions relative to the Loudspeakers. Use the Balance (Trim Function) as needed to achieve approxi-

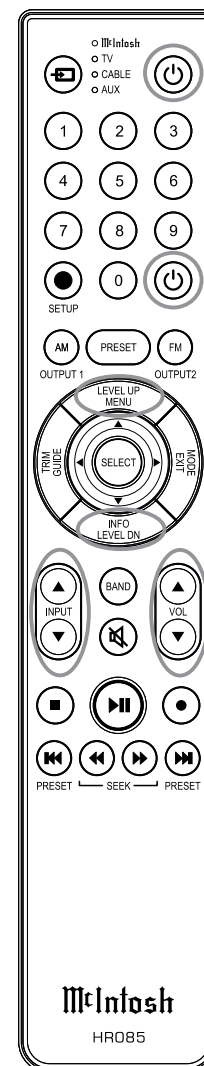

Figure 73

mately equal listening volume levels in each Loudspeaker. To adjust the Balance perform the following:

1. Press the TRIM Push-button repeatedly on the Remote Control until “L BALANCE R, ||” appears on the Front Panel Display. Refer to figure 74.



Figure 74

Note: The Front Panel INPUT/Trim Control may also be used.

2. Rotate the VOLUME/Adjust Control or press the LEVEL UP / DOWN Push-buttons on the Remote Control to emphasize the Right Channel (refer to figure 75) or the Left Channel (refer to figure 76).



Figure 75



Figure 76

The Front Panel Display indicates the relative Balance changes. After approximately 5 seconds, the Display returns to indicate the Source Selection and Volume Level. To verify the Balance setting without changing it, use the TRIM Push-button and select Balance.

TRIM LEVEL

Source Components can have slightly different volume levels resulting in the need to readjust the MAC7200 Volume Control when switching between different sources. The MAC7200 allows the adjustment of levels for each Source, ensuring the same relative volume. To adjust the Trim Level for the currently

selected Input Source perform the following steps:

1. Select “INPUT TRIM” as indicated on the Front Panel Information Display. Refer to figures 70, 73 and 77.

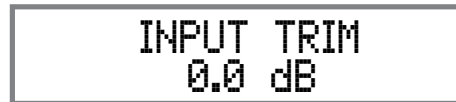

Figure 77

2. Adjust the Trim Level of each Input to match the average volume level of the Input most frequently listened to. The range of adjustment is ± 6.0 dB in half dB steps. Refer to figures 78 and 79.



Figure 78



Figure 79

After approximately 5 seconds the Information Display returns to indicate the Source Selection and Volume Level.

TONE CONTROL

The Tone Controls default setting is Off. The TRIM TREBLE and BASS Settings may be adjusted for the currently selected Input Source, by first setting the Tone Control Trim Setting to On. The LED above the TONE Push-button will be illuminated. When the Tone Controls are Disabled the previous settings for Treble and Bass are bypassed from the signal path. To deactivate Tone Controls perform the following:

1. Select the desired Input Source.
2. Press the TRIM Push-button on the Remote Control until “TONE CONTROLS, Off” appears on

the Front Panel Display. Refer to figure 80.



Figure 80

3. Press TRIM LEVEL UP / DOWN Push-button to activate the Tone Controls On. Refer to figure 81.



Figure 81

After approximately 6 seconds the Display returns to indicate the Source Selection and Volume Level.

BASS

The Intensity of the Low Frequencies in the music can be increased or decreased by using the Trim Select and Trim Adjust Controls. To make an adjustment perform the following:

1. Use the Front Panel INPUT/TRIM Control or press the TRIM Push-button on the Remote Control until “BASS 0 dB” appears on the Front Panel Information Display. Refer to figure 82.

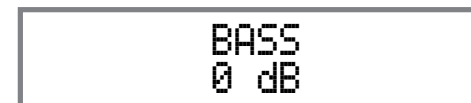

Figure 82

2. Rotate the INPUT/TRIM Control or press the LEVEL + / - Push-buttons to increase (refer to figure 83) or decrease (refer to figure 84 on page 30) the volume level of the low frequencies.



Figure 83



How to Operate the MAC7200, con't

BASS
-12dB

Figure 84

The Front Panel Display indicates the Bass changes in steps from +12dB to -12dB. After approximately 6 seconds the Display returns to indicate the Source Selection and Volume Level.

TREBLE

The Intensity of the High Frequencies in the music can be increased or decreased by using the Trim Select and Trim Adjust Control. To make an adjustment perform the following:

1. Use the Front Panel INPUT/TRIM Control or the TRIM Push-button on the Remote Control until “TREBLE, 0 dB” appears on the Front Panel Information Display. Refer to figure 85.

TREBLE
0 dB

Figure 85

2. Rotate the VOLUME/ADJUST Control or press the LEVEL UP / DOWN Push-buttons to increase

(refer to figure 86) or decrease (refer to figure 87) the volume level of the high frequencies.

TREBLE
+12dB

Figure 86

TREBLE
-12dB

Figure 87

The Front Panel Display indicates the Treble changes in steps from +12dB to -12dB. After approximately 6 seconds the Display returns to indicate the Source Selection and Volume Level.

PHONO ADJUSTMENTS

When the MC Phono Input is selected, an additional TRIM SELECT FUNCTION becomes available for adjustment. Perform the following steps to make the Phono Trim Adjustment:

1. Select the MC Phono Source Input.
2. Select TRIM “PHONO RESISTANCE, 400Ω” as indicated on the Front Panel Information Display. Refer to figure 88.

PHONO RESISTANCE
400Ω

Figure 88

3. Rotate the VOLUME/Adjust Control or press the LEVEL UP / DOWN Push-buttons on the Remote Control to select the Resistance Load that comes closest to the Phono Cartridge Makers recommended value.

After approximately 5 seconds the Alphanumeric Display returns to indicate the Source Selection and Volume Level.

MONO/STEREO MODE

By default the Stereo Mode is active for all Input Sources however, any Input Source may be assigned to Mono Mode. To change Stereo Mode to Mono for a given Input Source, perform the following steps:

1. Select the desired Input Source.
2. Select “MONO / STEREO, ” as indicated on the Front Panel Information Display. Refer to figure 89.

MONO / STEREO

Figure 89

3. To select MONO Mode adjust the TRIM LEVEL. Refer to figure 90.

MONO / STEREO

Figure 90

After approximately 5 seconds the Information Display returns to indicate the Source Selection and Volume Level.

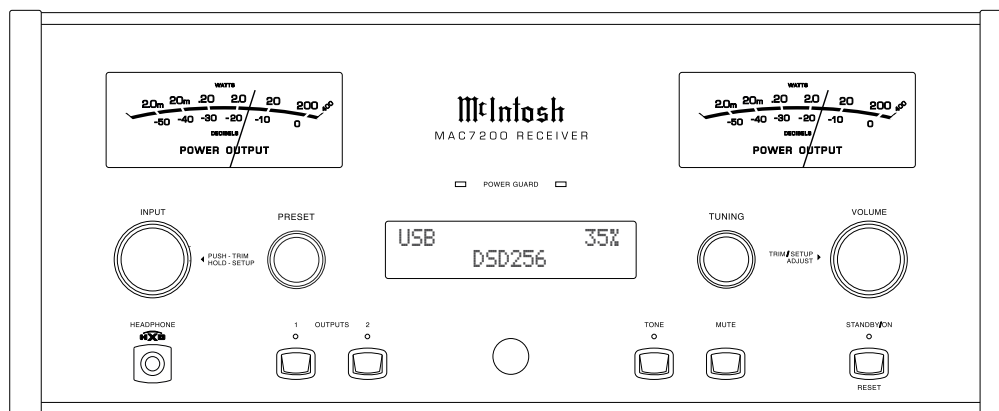

Figure 70

METER BACKLIGHT

The MAC7200 Front Panel Meter Illumination may be switched On or Off by performing the following:

1. Select "METER LIGHTS, On" as indicated on the Front Panel Information Display. Refer to figures 70, 73 (on page 28) and 91.



Figure 91

2. Switch Off the Meter Illumination. Refer to figure 92.



Figure 92

After approximately 5 seconds the Information Display returns to indicate the Source Selection and Volume Level.

- Notes:*
1. Meter Illumination of recent McIntosh Power Amplifiers will also switch On/Off when connected to the MAC7200 via a power control cable.
 2. Some A/V Processors will provide an On/Off Control Signal when the MAC7200 Passthru Input Jack is connected to the A/V Processor via the power control cable.

INFORMATION DISPLAY ILLUMINATION

The Brightness Level of the MAC7200 Front Panel Information Display can be adjusted from bright to dim by performing the following:

1. Select "DISPLAY BRIGHTNESS" as indicated on the Front Panel Information Display. Refer to figures 70, 73 (on page 28) and 93.
2. Reduce the Brightness level by adjusting the TRIM LEVEL. Refer to figure 94.



Figure 93



Figure 94

After approximately 5 seconds the Information Display returns to indicate the Source Selection and Volume Level.

HEADPHONE HXD

When headphones are connected to the MAC7200 Front Panel Jack, an additional TRIM function becomes available. McIntosh's HXD brings the acoustical depth and spatiality of music normally heard with loudspeakers, to your headphones. The default setting is HXD On. To switch HXD Off perform the following:

1. Momentarily press the INPUT Control, then rotate it to select "HEADPHONE HXD, On". Refer to figure 95.



Figure 95

2. To deactivate the HXD Mode rotate the VOLUME Adjust Control until the Front Panel Display indicates "HEADPHONE HXD, Off". Refer to figure 96.



Figure 96

Tone

Press the Front Panel TONE Push-button to activate the MAC7200 TREBLE and BASS Tone Control Circuitry for the currently selected Input Source. The LED above the TONE Push-button will illuminate. To bypass the TONE CONTROL CIRCUITRY for the currently selected Input Source press the TONE Push-button. The LED above the TONE Push-button will extinguish.

Trim

Press the Front Panel INPUT/TRIM Control to activate the MAC7200 Trim Functions. Rotate the Front Panel INPUT/Trim Control to select the desired Trim Function and then rotate the VOLUME/Adjust Control to vary or make changes. Refer to figure 50. The Remote Control TRIM and LEVEL UP and LEVEL DOWN Push-buttons may also be used. Approximately 5 seconds after Trim Function Selection and/or adjustments have stopped, the MAC7200 will switch off the Trim Mode.

Mute

Press the MUTE Push-button to Mute the Audio in Output 1 (Loudspeakers), Output 2 and Headphones. The audio signals present at the FIXED OUTPUT Jacks are not effected by activating the mute function. The Front Panel Display will indicate the Source Name and with the word MUTE in place of the actual volume setting. Refer to figure 97.



Figure 97

Pressing the Mute Push-button a second time or adjusting the volume control will un-mute the MAC7200.



How to Operate the MAC7200, con't

Headphones Jack

Connect a pair of dynamic headphones to the Headphone Jack with a 1/4" (0.635cm) stereo phone type plug for private listening. The default setting is for Output Connections 1 and 2 to automatically mute. For additional Information refer to "HEADPHONE HXD" on page 31.

Note: The Headphone Output is optimized for impedances ranging from 100 to 600 ohms.

Power Output Meters

The MAC7200 Power Output Meters indicate the power delivered to the Loudspeakers. Refer to figure 98. The meters respond to all the musical information

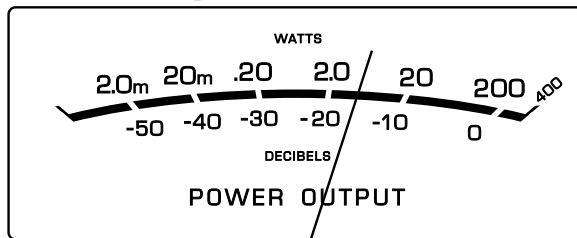

Figure 98

being produced by the Amplifier. They indicate to an accuracy of at least 95% of the power output with only a single cycle of a 2,000Hz tone burst.

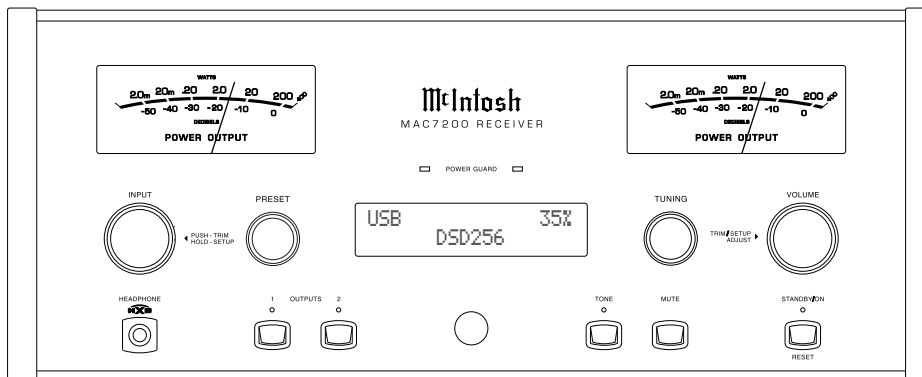

Figure 70

Power Guard

During normal operation, the Front Panel Power Guard Indicators will momentarily illuminate during peaks in the audio signals. In the event the MAC7200 overheats, due to improper ventilation, high ambient temperature and/or impedance mismatch, the internal protection circuits will activate. The Front Panel Power Guard Indicators will continuously illuminate and the audio will be muted. When the MAC7200 has returned to a safe operating temperature, normal operation will resume.

Using a Separate Power Amplifier

There are two different ways to use a separate power amplifier with a MAC7200. The first way is to use the separate amplifier instead of the MAC7200 built-in Power Amplifier. Connect the Loudspeakers to the separate Power Amplifier and remove the McIntosh Jumpers that are located between the OUTPUTS 1 Jacks and the PWR AMP INPUT Jacks. Refer to figure 99.

Note: The McIntosh Jumpers must be connected, between the above mentioned jacks, when the MAC7200 Internal Power Amplifier is to be used.

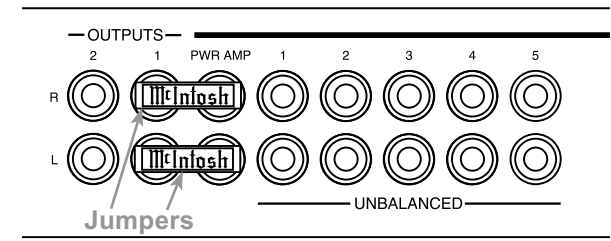

Figure 99

The second way is to use both a separate Power Amplifier and the MAC7200 built-in Power Amplifier. Connect one pair of Loudspeakers to the separate Power Amplifier and the second pair to the MAC7200. Refer to the MAC7200 Output Connection Diagrams located on the separate folded sheet "Mc2B" and figure 100.

Note: The MAC7200 VOLUME Control will affect the sound level of all the Loudspeakers.

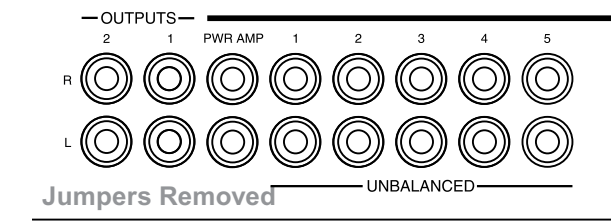

Figure 100

Using Output 2

The MAC7200 has provisions for connecting an external Power Amplifier (to drive Loudspeakers in another room) and an external sensor for remote operation of the MAC7200 from that room. With an external Power Amplifier connected (as illustrated on the McIntosh Connection Diagram separate sheet "Mc2B"), press the Front Panel OUTPUT 2 Push-button or press on the Remote Control, the BLUE (Setup) Push-button followed by pressing the OUTPUT 2 Push-button to switch On or Off the external Power Amplifier.

Passthru

When the MAC7200 is connected together with a McIntosh Multichannel A/V Control Center or Surround Decoder and has the PASSTHRU Mode activated, it will automatically turn-on when the A/V Processor or Surround Decoder is turned On. It will indicate on the Front Panel Display "PASSTHRU". Refer to figure 101.



Figure 101

The MAC7200 OUTPUT 1 / OUTPUT 2 Front Panel Push-buttons are active when in the Passthru Mode. The other Front Panel Controls and Push-buttons are deactivated as long as the Passthru Mode is active.

Optical and Coaxial Digital Inputs

When a Digital Input (Optical or Coaxial Connection) on the MAC7200 is selected, the Front Panel Display will indicate the sample rate when a signal is present "48kHz". Refer to figure 102.



Figure 102

During the time there is no Digital Signal present on the selected input the display will indicate "-----". Refer to figure 103.



Figure 103

Operating the FM and AM Tuner

The MAC7200 Tuner provides the ability to select and listen to AM and FM Radio Stations.

The Front Panel Controls labeled TUNING and PRESET allow the selection of either FM or AM Radio Stations. The Front Panel INPUT/TRIM Control, along with various push-buttons on the Remote Control provide access to various Tuner Operational Functions. Refer to figures 70 and 73.

The Front Panel Information Display indicates the Station Preset, Radio Station Frequency, Stereo/Mono (on FM Stations), Signal Strength, Tuning Method, Station Text, FM Signal Information. Refer to figures 104 thru 107.

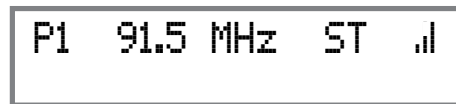

Figure 104



Figure 105

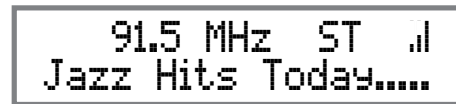

Figure 106



Figure 107

AM or FM Band Selection

Rotate the MAC7200 Front Panel INPUT Control to select either TUNER FM or TUNER AM. Refer to figure 70. The AM, FM or BAND Push-buttons on the Remote Control may also be used to select the desired Broadcast Band. Refer to figure 108.

Default Station Tuning

The default Station Tuning Mode for the MAC7200 is Manual. Manual Tuning is accomplished by using either the Front Panel TUNING Control or the Up▲ or Down▼ Directional Push-buttons on the Remote Control. Refer to figures 70 and 108.

Seek Tuning Type

The MAC7200 second form of Tuning Types is Seek Tuning. Seek Tuning automatically finds the next available Radio Station. To change from Manual Tuning to Seek Tuning activate the TRIM Mode using the Front Panel Controls or the Remote Control. Select TRIM Mode "TUNER CONTROL, Manual" and then select "TUNER CONTROL, Seek". Refer to figures 105 and 109.



Figure 109

There are three ways to use Seek Tuning. The first way is to use the Front Panel TUNING Control, by momentarily rotating it a few degrees clockwise or counter-clockwise. The second way is to use the Up▲ or Down▼ Directional Push-buttons on the

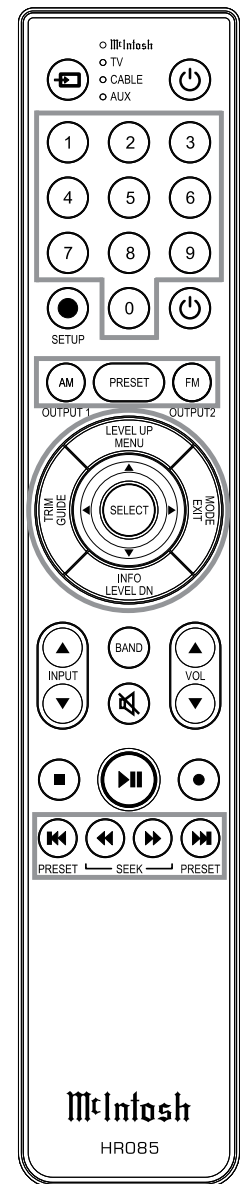

Figure 108



Operating the FM and AM Tuner, con't

Remote Control. The third way is to use the Seek ◀◀ or ▶▶ Push-buttons on the Remote Control. Refer to figure 70 and 108 on the previous pages.

Direct Access Tuning

The fourth Tuning way is to use the Direct Access Method for FM and AM Stations. This is performed by entering the Radio Station Frequency by using the numeric Push-buttons on the Remote Control. Refer to figure 108. For example, tuning to FM Station 105.7MHz press the following Push-buttons:

Number One, Number Zero, Number Five and Number Seven.

Preset Tuning

The MAC7200 allows for presetting 20 AM and 20 FM Radio Stations into memory for rapid recall. Refer to figure 108.

CREATE A PRESET

Perform the following steps:

1. Tune to the desired FM Station (or AM Station). Refer to Figure 110.



Figure 110

2. Press the large PRESET Push-button (located between the AM and FM Push-buttons) on the Remote Control and the letter “P” will appear flashing on the left side of the Front Panel Display. Refer to Figure 111.

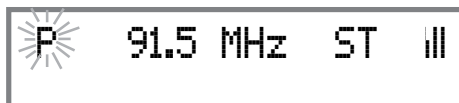

Figure 111

3. Using the Remote Control Numeric Push-buttons enter the desired Preset Number. Refer to Figure 112.



Figure 112

4. Press the large PRESET Push-button to complete the process of entering Preset One. The “P1” on the Front Panel Information Display will stop flashing. Refer to Figure 113.



Figure 113

ERASE A PRESET

Perform the following steps:

1. Use the Remote Control PRESET ◀◀, PRESET ▶▶ Push-buttons or the Front Panel PRESET Control to select the desired FM Station Preset (or AM Station Preset) to be erased. Refer to Figure 113.
2. Press the large PRESET Push-button (located between the AM and FM Push-buttons) on the Remote Control, “P1” will disappear and the letter “P” will appear flashing on the left side of the Front Panel Display. Refer to Figure 111.
3. Press the large PRESET Push-button a second time to complete the process of erasing Preset One. The Front Panel Information Display will now just indicate the Frequency, Mode and Signal Strength. Refer to Figure 110.

Note: If it is desirable to remove all 20 Presets (FM and/or AM Stations) refer to Setup “DELETING PRESETS” on page 25

SELECTING A PRESET

There are several ways to scan thru available FM or

AM Preset Stations. Rotate the Front Panel PRESET Control Clockwise or Counterclockwise to find the desired station. The second way is to use the Remote Control PRESET ◀◀, PRESET ▶▶ Push-buttons. The third way is using the Remote Control to direct access the desired Preset Number. First press the large PRESET Push-button, then use the numeric Push-buttons to enter the Preset Number followed by pressing the large PRESET Push-button a second time.

Tuner Text

Select the TRIM Tuner Text Mode using the Front Panel Controls or Remote Control. The default TRIM Tuner Mode is “Station Info” which indicates whatever a given Radio Station wants to display. Refer to figure 106 on page 33. The second option is to display the RF Multipath¹ Signal and Noise Background of the tuned in FM Station or the Signal Strength of the tuned in AM Station. Refer to figure 107 on page 33. The third option is to switch Off the second line of the Front Panel Information Display.

¹ Refer to “General Information” number 8 for addition information about RF Multipath Signals.

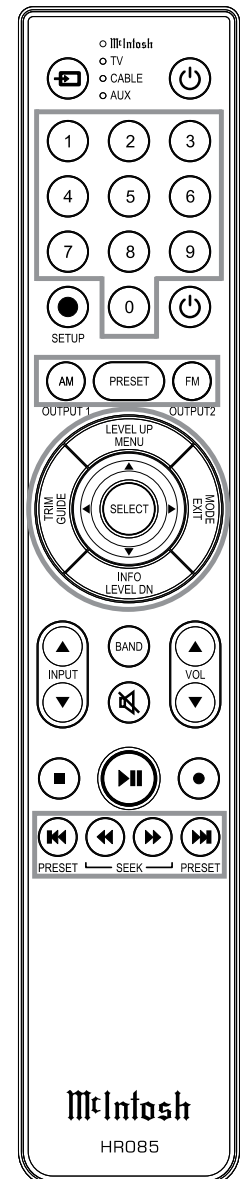

Figure 108

USB Input Operation and Driver Installation

The MAC7200 USB Input provides the capability to playback music from a computer, when the computer is connected to the rear panel USB connector.

Note: The USB Input is for direct connection to a computer only. To playback music from an USB Drive, connect the USB Drive to another USB Port on the computer and select the USB Drive with the Media Playback Program.

The MAC7200 USB Input is compatible with PC Computers using Microsoft®, Windows 7 (SP1), Windows 8.1 and Windows 10. It is also compatible with Apple® Macintosh® Computers using OS-10.6.8 or later.

When using a PC Computer with Windows, a special McIntosh USB Audio Software Driver needs to be installed on the PC Computer. The driver needs to be installed before connecting the MAC7200 USB Input to the USB Port on the computer.

Note: If an Apple Macintosh computer is used with the MAC7200, no additional driver is required.

The McIntosh USB Audio Windows Driver is available for download from the McIntosh Web Site: <http://www.mcintoshlabs.com/us/Support/Pages/Manuals.aspx>

Under “PRODUCT CATEGORY” select “Pre-amplifiers” then under “MODEL NUMBER” select “MAC7200”. Click on “SEARCH” then select “McIntosh-HD USB Audio Windows Drive D v1.0” and download the PC Windows Driver. Follow the instructions below to install the McIntosh MAC7200 Driver:

Purpose: To Install the McIntosh USB Audio Windows Driver for use with McIntosh Products with an USB-Digital Audio Input.

- Requirements:**
1. A PC Computer with a functioning USB Port.
 2. Windows 7 (SP1 or greater), Windows 8 (8.1) or Windows 10 Operating System.
 3. An USB Cable with Type A to Type B Connectors.

Installing the Software

It is important to first install the downloaded software on your computer before connecting the McIntosh Product to the computer. The USB Driver is included in the downloaded software package.

Note: Before installing this software, please check to see if the McIntosh Product(s) with the USB Digital Audio Input has the latest firmware version, if not update the firmware first.

1. Unzip the downloaded McIntosh Windows USB Driver Software Package.
2. Run “McIntoshHDSwPkg 20150814 v1p9p110p2.zip”. Refer to figures 114 thru 121.



Figure 114



Figure 115

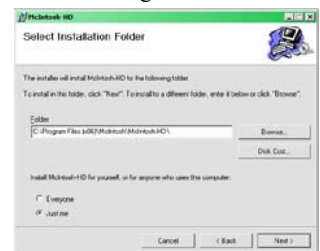

Figure 116

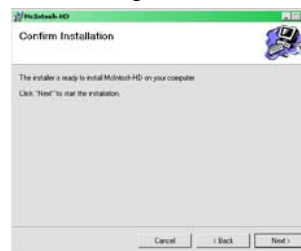

Figure 117

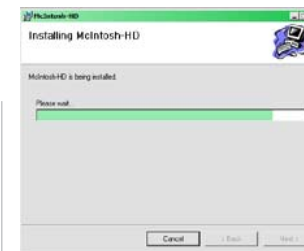

Figure 118



Figure 119



Figure 120



Figure 121

3. When the Windows Security window appears check the *Always trust software from “Savitech Corp.”* box and then the Install button. When the software has been installed, it is necessary to reboot the computer. Refer to figure 122.

After rebooting, a McIntosh-HD icon will appear on the desktop. Refer to figure 98.

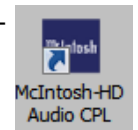

Figure 122

USB Connection

Connect the USB Cable with Type A to Type B connectors between the PC Computer and the McIntosh Product with the USB-Digital Audio Input. An Icon will appear On-Screen indicating Windows has found new hardware. Refer to figure 123.

Upon completion of installing the driver, figure 124 will appear.

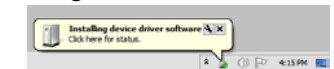

Figure 123

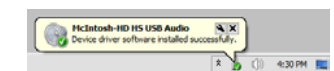

Figure 124

How to Operate the MAC7200, con't

Windows Sound Settings

For proper operation of the McIntosh Product via the Computer USB Connection, it is required to make changes to Windows Sound Settings:

1. From the Windows START button, click on "CONTROL PANEL" followed by selecting "SOUND". Refer to figure 125.
2. Referring to figure 126, first select "McIntosh-HD HS USB Audio" and then click on the "Set Default" button.



Figure 125



Figure 126

Notes: 1. When the McIntosh USB Audio Product is not connected to your computer, the previous default Audio Device will be selected.

2. If other McIntosh Products with USB Audio Connections are also connected to the computer, an additional "McIntosh USB Audio" playback device will appear in the listing. Make sure to select the "McIntosh HD HS USB Audio" from available playback devices listed when using this McIntosh Product for USB Audio.

Control Panel Settings

To activate the McIntosh-HD USB Audio Control Panel Click on the "McIntosh Icon" (located in the Windows notification area on the right side of the taskbar)

or Click on the Windows "Show hidden icons", then Select the "McIntosh Icon". Refer to figures 127 and 128.

Notes: 1. It is not necessary for the McIntosh HD USB Audio Control Panel to be running, unless it is desired to make changes to the default settings.

2. The McIntosh HD USB Audio Control Panel displays the current Sampling Rate, Bit Rate and Buffer Size for the music streaming from the computer into the MAC7200.

3. When the Media Stream Program on the computer is set to output in the "ASIO" format, the McIntosh HD USB Audio Control Panel allows for changing the settings parameters on the fly.

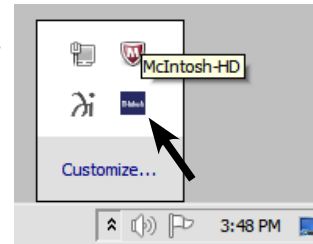

Figure 127



Figure 128

USB Music Playback

When the USB Input is selected on the McIntosh MAC7200, the Front Panel Display indicates the

Sampling Rate (refer to figures 129 and 130 for PCM Signals).



Figure 129



Figure 130

Figures 131 and 132 indicate a Sampling Rate of 128 or 256 times the Sampling Rate of a CD Disc for the incoming DSD Digital Audio Signal.

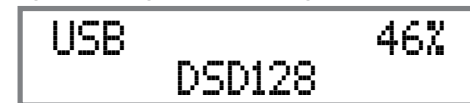

Figure 131



Figure 132

The Sampling Rate and the Bit Rate are determined by the original recording, the Application Output Format (when available) and the McIntosh-HD Control Panel Settings.

Note: In general, when the original music is recorded at a higher Sampling Rate, the result is usually more detail in the music. However, this higher rate results in consuming larger amounts of storage space. The Sample Rate usually should be set to match the Sample Rate of the music recording being played back.

There are many third party Applications (besides Applications like Windows Media Player) for steaming music from the computer to McIntosh MAC7200 USB Input. An example of just one of the available applications is "JRiver Media Center".

Amplifier Specifications

Power Output

200 watts is the minimum sine wave continuous average power output per channel, both channels operating

Output Load Impedance

2, 4 or 8 ohms

Rated Power Band

20Hz to 20,000Hz

Total Harmonic Distortion

0.005% maximum with both channels operating from 250 milliwatts to rated power, 20Hz to 20,000Hz

Intermodulation Distortion

0.005% maximum, if the instantaneous peak power is 400 watts or less per channel with both channels operating for any combination of frequencies from 20Hz to 20,000Hz

Dynamic Headroom

2.0dB

Wide Band Damping Factor

Greater than 40

Power Guard

Less than 2% THD with up to 16dB overdrive at 1,000Hz

Frequency Response

+0, -0.5dB from 20Hz to 20,000Hz
+0, -3dB from 10Hz to 100,000Hz

Preamplifier Output 1 and 2 (for rated input)

1.4V unbalanced (8V Maximum)

Sensitivity (for rated output)

High Level, 250mV unbalanced, 500mV balanced
Phono MM, 2.5mV
Phono MC, 0.25mV
Power Amp In, 1.4V

Signal To Noise Ratio (A-Weighted)

High Level, 95dB below rated output
Phono MM, 82dB below 5mV input
Phono MC, 80dB below 0.5mV input
Power Amplifier, 113dB below rated output

Input Impedance

High Level, 20K ohms
Phono MM - 47K ohms; 50pF
Phono MC - 50, 100, 200, 400 or 1,000 ohms; 100pF

Preamplifier Output Impedance

220 ohms

Maximum Input Signal

High Level, 8V unbalanced, 16V balanced
Phono MM, 80mV

Maximum Input Signal, con't

Phono MC, 8mV
Power Amplifier In, 16V

Preamplifier Output Impedance

220 ohms

Headphone Impedance

100 to 600 ohms

Voltage Gain

High Level to Output 1 and 2: 15dB
Phono MM to Rec Output: 40dB
Phono MC to Rec Output: 60dB
Phono MM to Output 1 and 2: 55dB
Phono MC to Output 1 and 2: 75dB
Power Amplifier: 29dB

Power Control and Trigger Output

12VDC, 25mA

MAC7200 Tone Control Curves

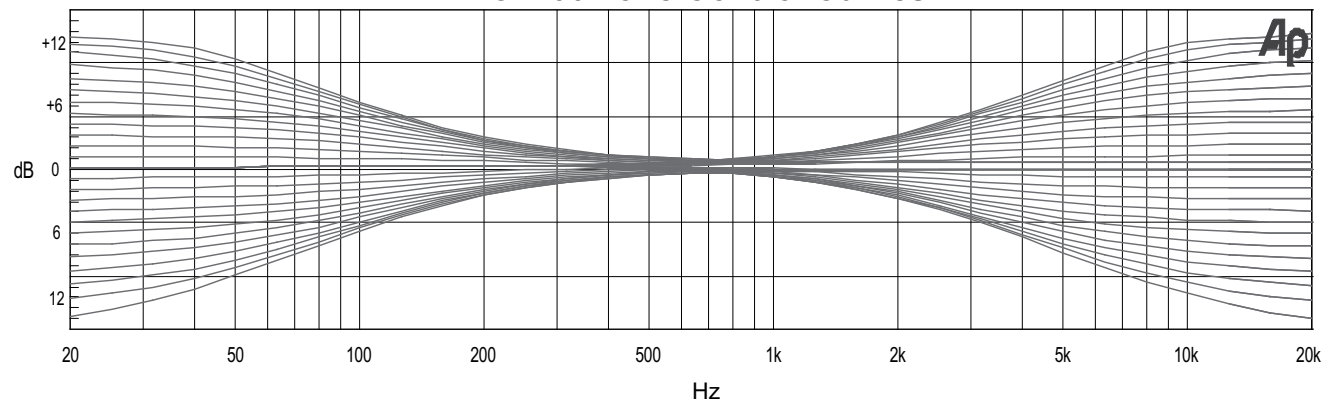



Digital Audio Specifications

Digital Input Signal Format

Coaxial and Optical Inputs - SPDIF (PCM)
MCT and USB Inputs - PCM, DSD

Digital Input Sample Rate

Coaxial and Optical: 44.1kHz to 192kHz, 24-Bit
MCT: 44.1kHz, 16-Bit (CD)
DSD64 (SACD)
USB: 44.1kHz to 384kHz, 32-Bit (PCM)
DSD64, DSD128, DSD256,
DXD352.8kHz, DXD384kHz

Digital Inputs

Coaxial: 0.5V p-p/75 ohms
Optical: -15dbm to -21dbm (TOS Link)
MCT: 0.5V p-p/75 ohms
USB: USB Type B Connector

Tuner FM Specifications

Tuning Range

87.5MHz - 108.0MHz (Europe)
87.9MHz - 107.9MHz (USA)
76MHz - 90MHz (Japan)

FM Channel Spacing

200kHz (USA, Japan)
50kHz (Europe)

Antenna Input

75 Ohms, Type "F" Coax connector

Useable Sensitivity

2.2uV (18.1dBf)

50dB Quieting Sensitivity

1.5uV (14.8dBf)

Tuner FM Specifications, con't

Signal To Noise Ratio

Mono: 70dB
Stereo: 68dB

Frequency Response

±1dB 20 to 15,000Hz

Harmonic Distortion

Mono: 0.4%
Stereo: 0.8%

Channel Selectivity

60dB Adjacent Channel
66dB Alternate Channel

Stereo Separation

38dB

Tuner AM Specifications

AM Tuning Range

522kHz - 1602kHz (Europe)
530kHz - 1710kHz (USA)
522kHz - 1611kHz (Japan)

AM Channel Spacing

10kHz (USA)
9kHz (Europe, Japan)

Sensitivity

350uV/m

Signal To Noise Ratio

50dB

Frequency Response

0dB, -6dB 50Hz to 3,000Hz

Tuner AM Specifications, con't

Harmonic Distortion

0.5%

Selectivity

45dB Adjacent Channel

General Specifications

Power Requirements

Field AC Voltage conversion of the MAC7200 is not possible. The MAC7200 is factory configured for one of the following AC Voltages:

100 Volts, 50/60Hz at 5.2 amps
110 Volts, 50/60Hz at 4.4 amps
120 Volts, 50/60Hz at 4.4 amps
220 Volts, 50/60Hz at 2.45 amps
230 Volts, 50/60Hz at 2.35 amps
240 Volts, 50/60Hz at 2.25 amps
Standby: Less than 0.25 watt

Note: Refer to the rear panel of the MAC7200 for the correct voltage.

Overall Dimensions

Width is 17-1/2 inches (44.45cm)
Height is 7-5/8 inches (19.37cm) including feet
Depth is 22 inches (55.88cm) including the Front Panel, Knobs and Cables

Weight

75 pounds (34.1 kg) net, 93 pounds (42.3 kg) in shipping carton

Shipping Carton Dimensions

Width is 29-1/2 inches (74.93cm)
Depth is 29 inches (73.66cm)
Height is 17 inches (43.18cm)

Packing Instructions

In the event it is necessary to repack the equipment for shipment, the equipment must be packed exactly as shown below. It is very important that the four plastic feet are attached to the bottom of the equipment. Two #10 x 2-1/2 inch screws and washers must be used to fasten the unit securely to the bottom pad and wood skid. This will ensure the proper equipment location on the bottom pad. Failure to do this will result in shipping damage.

Use the original shipping carton and interior parts only if they are all in good serviceable condition. If a shipping carton or any of the interior part(s) are needed, please call or write Customer Service Department of McIntosh Laboratory. Refer to page 2. Please see the Part List for the correct part numbers.

MAC7200 Packing Material List

Quantity	Part Number	Description
1	033888	Shipping carton
4	033887	End Cap
1	033697	Inner carton
1	033725	Top pad
1	034576	Bottom pad
1	034480	Wood skid
2	017218	Plastic foot (spacer)
2	401204	#10 x 2-1/2 inch wood screw
2	404033	#10 flat washer 1-3/4 inch
4	017937	Plastic foot
4	400159	#10-32 x 3/4 machine screw
4	404080	#10 flat washer

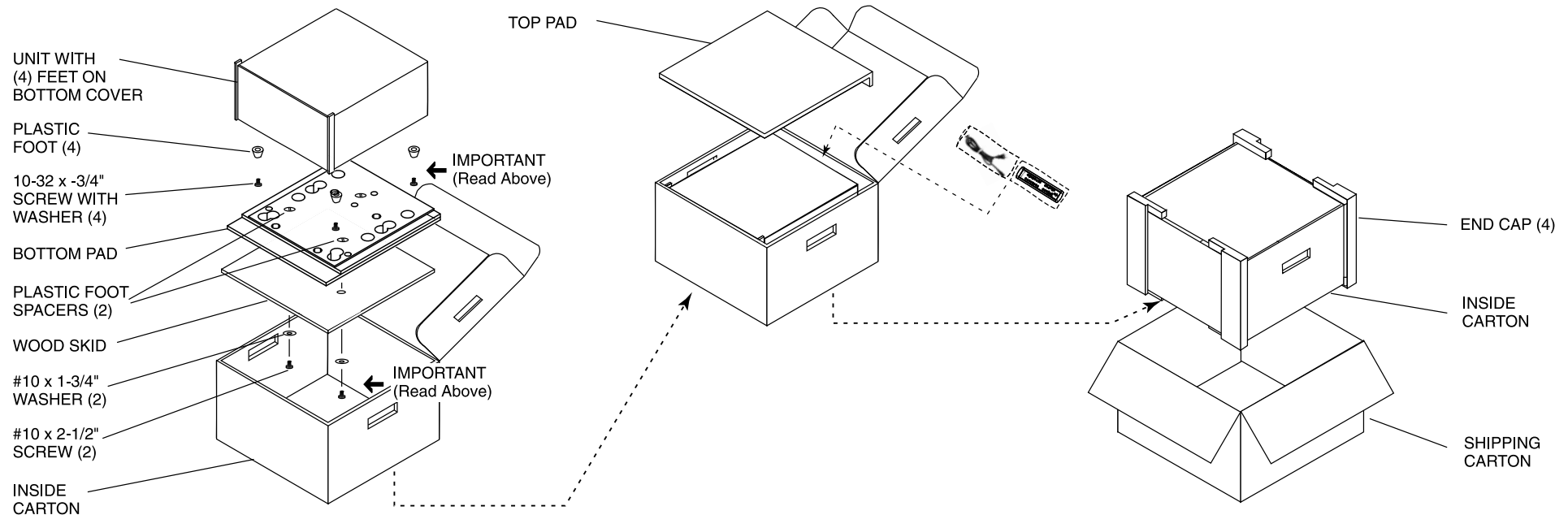



McIntosh Laboratory, Inc.
2 Chambers Street
Binghamton, NY 13903
www.mcintoshlabs.com

The continuous improvement of its products is the policy of McIntosh Laboratory Incorporated who reserve the right to improve design without notice.
Printed in the U.S.A.